



The Original OEM Manufacturer



For Over 66 Years

Your Single Source!



The Crown 2016 Product catalog

Welcome!...to the Crown family of products

About us...

Crown Engineering Corporation...the Manufacturer!

Crown Engineering Corporation is one of the largest manufacturers of electrodes, flame rods, and probes for ignition related applications regarding oil and gas fired equipment. We manufacture many of the electrodes for today's waste oil burners. Our ignition electrodes can be found in **Beckett AFII** burners, **Wayne Blue Angel** oil burners, **Carlin's Elite** oil burners, **Midco** power gas burners, **Wayne** power gas burners, **Fulton** boilers, and **Kewanee** boilers. We have designed and supplied ignition products for grain drying equipment. Our products can even be found in hot water heaters, pressure washers, and diesel truck heaters, of all places!

Crown Engineering Corporation is also a manufacturer of terminal connectors. Our connectors are used in power source applications between electrode and transformer. We also manufacture connector to connector cable assemblies for **Fulton Boiler Co.**

Crown Engineering Corporation...the Distributor!

In addition to manufacturing electrodes and terminals for our customers we are swamped with numerous requests for other related products. We rose to the demands of our customers needs. After we began our, "Single Source!", campaign, it lead to an onslaught of numerous distribution items. These products range from industrial igniters, couplers, putty, gauge glass and fractional v-belts.

In Closing...

Crown Engineering is proud to present our 2016 Product Catalog, featuring over 1800 different cataloged products. Take the time to look through it. This is our most informative and organized edition ever! Our OEM electrode section has extras, such as, OEM part numbers and model number information, and updated photos and line art for many of the old Crown favorites have been added, and continuous page numbers with Section numbers instead of alpha sections. Our "on edge description tabs," makes thumbing through sections easier than ever. So, don't judge our book by it's cover! Literally! Take a look inside, there's more!.

We graciously welcome you, and thank you for choosing our company as a source of supply. We hope to serve you humbly for many years to come. If at any time you are not completely satisfied with the product(s), and service we offer, please do not hesitate to openly discuss the problem with us. With Crown there is never a problem that cannot be solved. We think of you as more than just a customer...we treat all our customers like family!. We look forward to hearing from you.

Sincerely,

Michael J. Palmer
President



Product Index “A” through “H”

A		Ceramic putty - Thermeez®	79	Filter mounting head for QS III	94
A pump strainer gaskets	100	Ceramic roping	77	Filter modification mounting kit	94
A pump strainers	98	Champion Spark Plugs	40	Friction Rings - Brass	114
Adams/Beckett electrode kit	32	Chem Flush-1	104	Flame detectors	67, 72
Air Cones for Beckett Burners	123	Chem Flush valve	104	Flame detector cad cell	72
Air Cones for Wayne Burners	122	Chem Flush valve sight tube	104	Flame rods, Auburn®	43
Anti-Hum Device - Silent Flow	91	Circulator couplings	86	Flame rods, Crown	58, 59
Armstrong / B & G Couplers	85	Circulator lube oil	86	Flexible braided hose	97, 98
Aquastat immersion wells	112	CO ² blow out guns	108, 109	Flow Control® de-aerator	96
Auburn® electric feed-throughs	39	CO ² cartridges 6, 12 & 16 gram	110	Fulflo filter elements	92
Auburn® igniters & flame rods	43-48	Compound gauge - Color coded	96	Fusible valves - Firomatic®	102, 103
Auburn® liquid level electrodes	49	Control Blast	109	Furnace cement	81
Auburn® observation ports	51	Conversion chart	30	Fulflo gaskets	101
		Copper oil Lines - Streamline®	91		
B		Cotton filter elements	92	G	
Beckett air cones	123	Coupler tubing, Bulk	84	Gaskets	79 - 81
Beckett electrode kits	35 - 38	Coupling cutter tool	84, 106	Gasket, Utility roll	80
Beckett flange kit	79	Coupling end caps	84	G. E. Door Gasket	80
Beckett gaskets	79	Coupling kit	83	Gauges	95, 96
Beckett Igniton Leads Set	31	Coupling tools	106	Gauge Glass Valves	114
B & G Couplers / Armstrong	85	Cover gasket for		Gauge Glass - High Pressure	115
Blow out gun	108, 109	Heil / Bradford / Olsen	80	Gauge Glass protector rods	118
Boards, refractory	79			Gauge Glass porcelain cutter	108
Boots, silicone & ceramic	50, 51	D		Gauge Glass - Redline	117
Braided flex hose	97, 98	De-aerator - Flow Control®	96	Gauge Glass - Redline heavy wall	118
Braided Rope - High Temp.	77	De-greaser	104	Gauge Glass - Standard	115
Brass friction rings	114	Decimal Conversion Chart	30	Gauge Glass Washers - Marvel®	113
Beckett solid state ignitor	36	Digital pocket dial thermometer	105	Gauge Glass packing nut kit	114
Burner Coupling & Kits	83, 84	DO-ALL+ Furnace cement	81	Gauge Glass Washers - Standard	114
Burner Couplings - Bulk & OEM	83, 84			GTO-15 cable	68
Burner Couplings, Pioneer	83	E			
Burner Gaskets - Assorted	80, 81	Electrode replacement rod paks	67	H	
Buss Bars	67	Electrode Setting Gauges	110	Handi-Kutter & Blades	84
		Electrode tip benders	109	Handi-Kutter & Kits	84
C		Electrodes, All	5 - 29	Heavy duty coupling cutter	106
Carlin electrode kits	35	Electrodes, OEM	5 - 28	Heavy Wall Red Line GG	118
CA Series industrial		Electrodes, Standard	29	Heil/Brad/Olsen cover gasket	80
igniters & flame Rods	52	Electrode ignition kits	32 - 35	Hi-Temp rope	77
Cable Reels - Empty	68	Electric Feed-throughs	39	Hi-Temp Wire Leads	76
Cable, GTO-15 - 7mm	68	End cones, Beckett	123	Honeywell cad cell kit	67
Cable leads for Honeywell	76	End cones, Wayne	122	Honeywell Flame detectors	67
Cable leads for Weil-McLain	76			Hub-Adaptors, Splined	84
Cable, Silicone - 7mm	68	F		Hydronic circulator lube oil	86
Cad Cell Eyes	72	Fast drying de-greaser	104		
Carlin gaskets	79 - 81	Fiberglass rope	81		
Carlin gasket kit	81	Fiberfrax® gasket paper	78		
Cartridges, CO ²	110	Fiberglass tape	78		
Ceramic Boots with terminals	50, 51	Filters	92, 93, 94		
Ceramic cutting tool	108	Filter gaskets	100		
Ceramic Fiber Blankets	76	Filter mounting bracket	94		



Product Index “I” through “Z”

I	O-ring gasket, Riello	100	Standard gauge glass washers	114	
Igniter development page	66	P	Strainers	98, 99	
Igniters & Flame rods, Auburn®	43 - 48	Packing nuts & kit			
Igniters & Flame rodss, Crown	52 - 65	Pioneer coupling products	83, 84	T	
Igniter Hardware	71, 72	Pliers, Lineman	106,110	Taco couplings	85
Ignition terminals	73, 74	Pocket dial thermometer	105	Tape, Fiberglass	78
Ignition terminal kits	69, 70	Porcelain & glass cutter	108	Tank gauge - Rope type	96
Immersion wells aquastat	112	Pressure & cut-off test kit	111	Target boards, Refractory	79
Inspection mirrors, Telescoping	105	Pressure gauges	95	Telescoping mirror tools & kits	105
Insulator, Standard	29	Prodes - S/S & Brass	51	Terminal crimping tools	106, 107, 110
Insulators, Spider	28	Pump cover gasket, Riello	100	Terminal ignition kits	69, 70, 75
		Pump strainer gskt & kits	98 - 101	Terminal Kit - “Big Box”	75
		Pump test kits	111, 112	Terminals / Rajah Style	73, 74
J		Q		Test leads w/boots	68
J,H,S pump strainer gaskets	100	Quick-Spin III filtration system	93, 94	Thermeez® ceramic putty	79
J,H,S pump strainers	98	Quick-Spin III filtration kits	94	Thermo Pride cover gasket	80
Jumper leads	68			Thermometers - Pocket dial	105
		R		Thermometer with spud well	95
K		Ratchet box wrench	109	Tip benders, Electrode	109
Koupling King II products	83, 84	Rayon filter	92	Tools	105 - 110
KK400 Ultra Koupling Kit	83	Ready Fit™ couplings	83	Transformer contact kit	69, 74
		Red line gauge glass	117, 118	Tridicator / Boiler gauges	95
L		Replacement blades for 40402	106	Trouble Shooting Guide	82
Lineman’s crimper	106, 110	Refractory boards	79	Tubular gauge glass	115 - 118
Lineman’s strip n’ crimp	110	Riello air tube gasket	80	Twisted Rope - High Temp.	77
Liquid level probes	49	Riello flexible hose	98		
Low voltage test leads	68	Riello o-ring	100	U	
		Riello pump strainer	99	Universal gasket - No bolt holes	80
M		Riello pump & vacuum tester	111	Utility gasket roll	80
Manufacturers Rep Lisiting	90	Rope, Braided	77		
Marvel® gauge glass washers	113	Rope, Fiberglass	81	V	
Match holder	105	Rope, Twisted	77	Vacuum gauges	95
Miller gaskets & kits	80, 81			Valker® Products, All	104
Miller oil line kit	91	S		V- Belts - Fractional	119
Mirror, telescoping	105	Setting gauge, Electrode	110		
Moroso® crimping tools	107	Silent Flow	91	W	
		Silicone Boots	50	Washers, All	113, 114
N		Silicone cable	68	Webster vacuum breaker	110
Nozzle wrench tool	109	Silicone Tape	112	Wayne flange gaskets	79
		Smoke Candles - Superior	104	Wayne tune up kits	31, 32
O		Smoke Emitters - Regin	104	Weil-McLain tune up kit	31
Observation Ports - Auburn	51	Smoke test paper	104	Wix oil filter elements #24104	92
Observation Ports - Lenz Brand	51	Solderless terminals	75	Woods™ Couplers & Sleeves	87 - 89
OEM coupling kits	83	Solderless Wire Terminals & Kits	75		
OEM electrodes	5 - 28	Soot kutter	107	X, Y	
Oil Filters	92 - 94	Spark plug terminals & boots	50, 51	No entries	
Oil lines - Flexible	97, 98	Spark plugs, Champion	39 - 42		
Oil line flexible, Riello	98	Spark plug crimping tool	107	Z	
Oil line tubing, Copper	91	Spin-on filters	93, 94	Zoom type - circulator lube oil	86
Oil line, Miller	91	Spring / Coiled Circulator Couplers	85		
Oil safety valves - Webster®	102				



CROWN P/N: 20005 **NAME:** ACE **OEM P/N:** 212096
MODELS: UNKNOWN

CROWN P/N: 20155 **NAME:** AMERICAN STANDARD
OEM P/N: 95603 **MODELS:** "E" FOR SHELLHEAD

CROWN P/N: 20075 **NAME:** AERO **OEM P/N:** UNKNOWN
MODELS: E & EHS

CROWN P/N: 20165 **NAME:** AMERICAN STANDARD
OEM P/N: 23411 **MODELS:** DH-23-T

CROWN P/N: 20076
NAME: AERO
OEM P/N: 27-25132100
MODELS: FAFC, HF-U5, HFAFC.

CROWN P/N: 20188
NAME: AXEMAN-ANDERSON
OEM P/N: LH 144539-7 & RH 144538-7
MODELS: UNKNOWN

CROWN P/N: 20077
NAME: AERO
OEM P/N: 27-25132100
MODELS: FAFC, HF-U5, HFAFC.

CROWN P/N: 20195 **NAME:** ARMSTRONG **OEM P/N:** 215-01A
MODELS: UNKNOWN

CROWN P/N: 20080 **NAME:** AERO **OEM P/N:** UNKNOWN
MODELS: G & GHS

CROWN P/N: 20197 **NAME:** AUBURN **OEM P/N:** UNKNOWN
MODELS: "AA" TURBULATOR

CROWN P/N: 20125 **NAME:** AMERICAN STANDARD
OEM P/N: 11385 **MODELS:** PH

CROWN P/N: 20200 **NAME:** ABC / SUNRAY **OEM P/N:** UNKNOWN
MODELS: UNKNOWN

CROWN P/N: 20135 **NAME:** AMERICAN STANDARD
OEM P/N: 15156 **MODELS:** DH & PH2

CROWN P/N: 20205 **NAME:** ABC / SUNRAY **OEM P/N:** UNKNOWN
MODELS: UNKNOWN

CROWN P/N: 20140 **NAME:** AMERICAN STANDARD
OEM P/N: 72918 **MODELS:** ARCO FLAME OIL BURNERS

CROWN P/N: 20220 **NAME:** ABC / SUNRAY **OEM P/N:** SA-8892
MODELS: 55A

CROWN P/N: 20150 **NAME:** AMERICAN STANDARD
OEM P/N: 94121 **MODELS:** "E" STANDARD HIGH & LOW PRESSURE

CROWN P/N: 20230 **NAME:** ABC / SUNRAY **OEM P/N:** A9806-R-6 1/2
MODELS: 45 & 55J



<p>CROWN P/N: 20240 NAME: ABC / SUNRAY OEM P/N: SA-9899 MODELS: UNKNOWN</p>	<p>CROWN P/N: 20395 NAME: BAXTER OEM P/N: V9-119 MODELS: UNKNOWN</p>
<p>CROWN P/N: 20245 NAME: ABC / SUNRAY OEM P/N: SA-10360 MODELS: 45</p>	<p>CROWN P/N: 20396 NAME: BAXTER OEM P/N: UNKNOWN MODELS: UNKNOWN</p>
<p>CROWN P/N: 20250 NAME: ABC / SUNRAY OEM P/N: SA-10112 MODELS: 75</p>	<p>CROWN P/N: 20404 NAME: BECKETT OEM P/N: UNKNOWN MODELS: UNKNOWN</p>
<p>CROWN P/N: 20310 NAME: ABC / SUNRAY OEM P/N: SA-11495 MODELS: 97AT & 97A HILO BURNER</p>	<p>CROWN P/N: 20410 NAME: BECKETT OEM P/N: UNKNOWN MODELS: SF, AF, & AFG UNDER 9" AIR TUBE</p>
<p>CROWN P/N: 20315 NAME: ABC / SUNRAY OEM P/N: SA-11497 MODELS: 97AT & 97A HILO BURNER</p>	<p>CROWN P/N: 20411 NAME: BECKETT OEM P/N: UNKNOWN MODELS: UNKNOWN</p>
<p>CROWN P/N: 20325 NAME: ABC / SUNRAY OEM P/N: SA-11446 MODELS: 62A & 96A</p>	<p>CROWN P/N: 20412 NAME: BECKETT OEM P/N: UNKNOWN MODELS: SF, AF, & AFG OVER 9" AIR TUBE</p>
<p>CROWN P/N: 20330 NAME: ABC / SUNRAY OEM P/N: SA-12823 MODELS: 40CN & 92C</p>	<p>CROWN P/N: 20413 NAME: BECKETT OEM P/N: UNKNOWN MODELS: UNKNOWN</p>
<p>CROWN P/N: 20335 NAME: ABC / SUNRAY OEM P/N: SA-12979 MODELS: MIGHTY MITE S, S1 & S2</p>	<p>CROWN P/N: 20414 NAME: BECKETT OEM P/N: UNKNOWN MODELS: MILLER FURNANCE - AF15 BURNER</p>
<p>CROWN P/N: 20340 NAME: ABC / SUNRAY OEM P/N: UNKNOWN MODELS: UNKNOWN</p>	<p>CROWN P/N: 20415 NAME: BECKETT OEM P/N: UNKNOWN MODELS: UNKNOWN</p>



Section 1: Electrodes

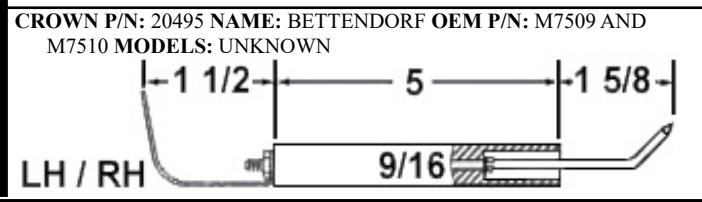
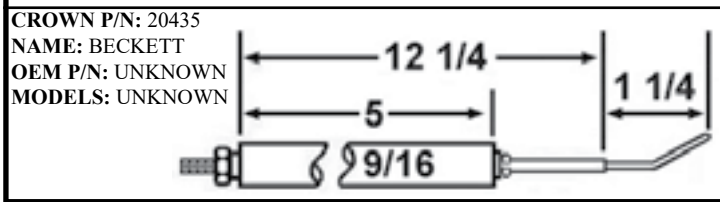
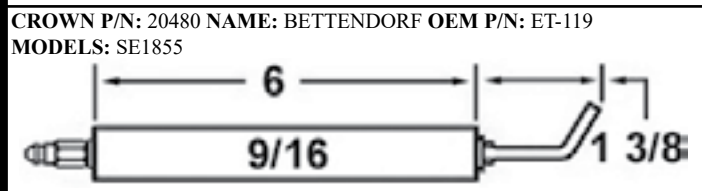
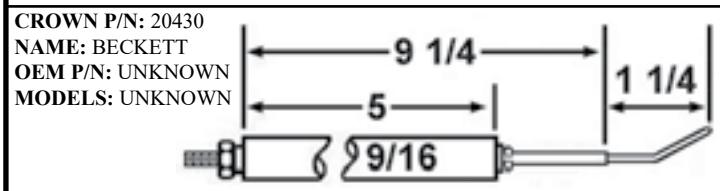
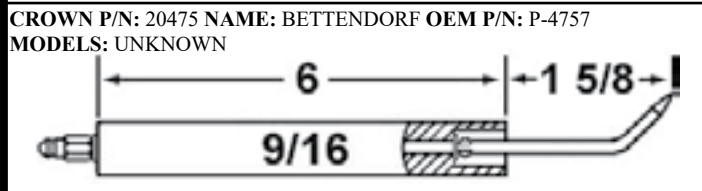
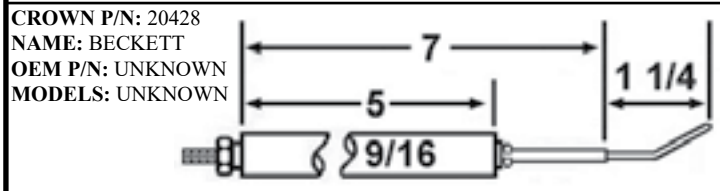
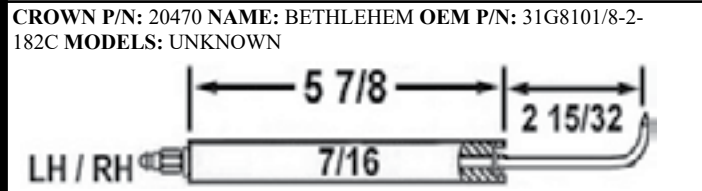
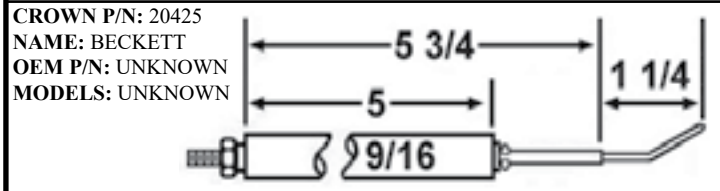
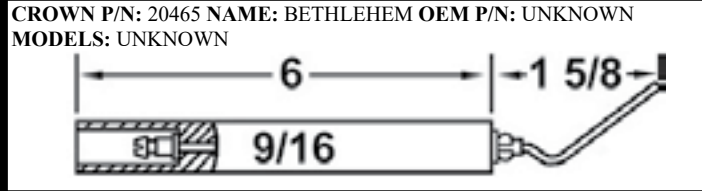
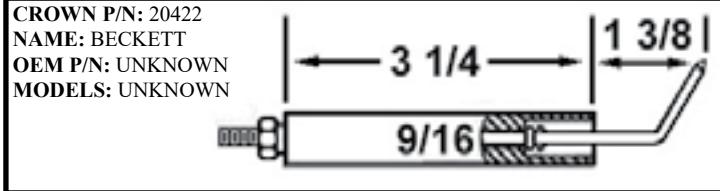
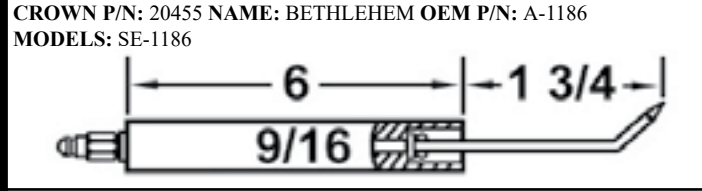
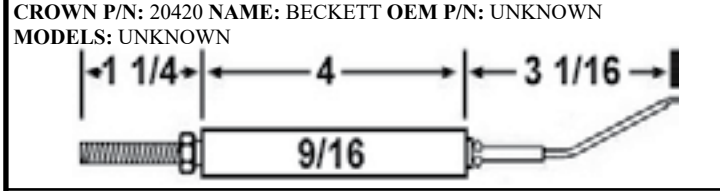
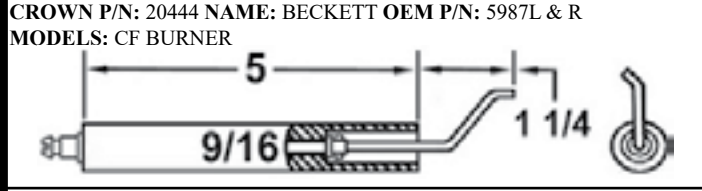
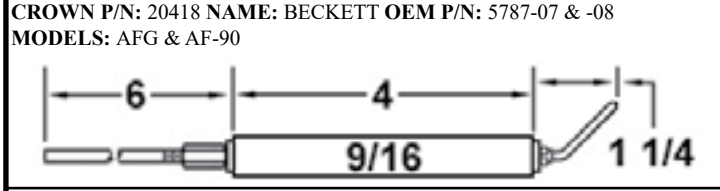
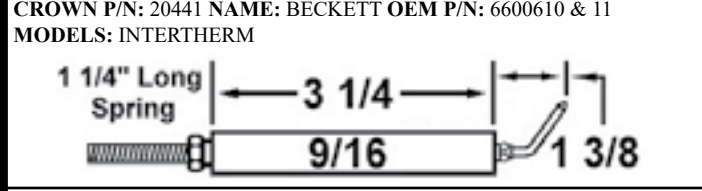
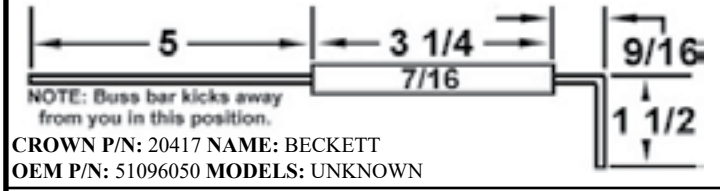
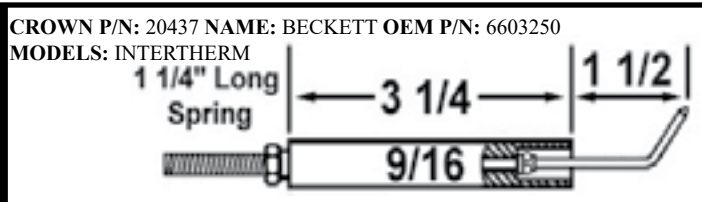
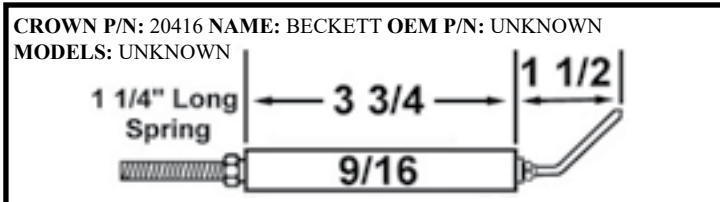



<p>CROWN P/N: 20500 NAME: BETTENDORF OEM P/N: M7428 & M7429 MODELS: UNKNOWN</p>	<p>CROWN P/N: 20709 NAME: CARLIN OEM P/N: UNKNOWN MODELS: UNKNOWN</p>
<p>CROWN P/N: 20505 NAME: BETTENDORF OEM P/N: M7512 & M7513 MODELS: UNKNOWN</p>	<p>CROWN P/N: 20710 NAME: CARLIN OEM P/N: A452 MODELS: 500, 600 & 800 CRD</p>
<p>CROWN P/N: 20510 NAME: BETTENDORF OEM P/N: M7612 & M7613 MODELS: UNKNOWN</p>	<p>CROWN P/N: 20720 NAME: CARLIN OEM P/N: A106 MODELS: 501, 600, 601, 701, 801, 1050 & 1150 CRD JACOBS LADDER</p>
<p>CROWN P/N: 20532 NAME: BETTENDORF OEM P/N: M7630 & M7631 MODELS: OHP32-3</p>	<p>CROWN P/N: 20725 NAME: CARLIN OEM P/N: UNKNOWN MODELS: UNKNOWN</p>
<p>CROWN P/N: 20535 NAME: BETTENDORF OEM P/N: M7658 & M7659 MODELS: OHP30-5</p>	<p>CROWN P/N: 20730 NAME: CARLIN OEM P/N: UNKNOWN MODELS: UNKNOWN</p>
<p>CROWN P/N: 20540 NAME: BETTENDORF OEM P/N: P-8-9884 & 9885 MODELS: UNKNOWN</p>	<p>CROWN P/N: 20760 NAME: CARLIN OEM P/N: A110 MODELS: 150 SERIES</p>
<p>CROWN P/N: 20545 NAME: BETTENDORF OEM P/N: P-8-9312 & 9313 MODELS: UNKNOWN</p>	<p>CROWN P/N: 20770 NAME: CARLIN OEM P/N: A280 MODELS: 98-102, 100-101, 200-201 & 301 CRD 1/16" DIA ROD</p>
<p>CROWN P/N: 27247 NAME: BLACK GOLD OEM P/N: BN710 MODELS: 140, 200, & 340</p>	<p>CROWN P/N: 20775 NAME: CARLIN OEM P/N: A457 MODELS: 99FRD 1/16" DIA ROD</p>
<p>CROWN P/N: 20569 NAME: BLUERAY OEM P/N: CRN-14 MODELS: UNKNOWN</p>	<p>CROWN P/N: 20779 NAME: CARLIN OEM P/N: A457 MODELS: 99FRD 1/8" DIA ROD WITH 30 DEGREE TIP</p>



Section 1: Electrodes

CROWN P/N: 20780 **NAME:** CARLIN **OEM P/N:** A766 **MODELS:** 98 102, 100-101, 200-201 & 301 CRD
 1/8" DIA. ROD WITH 30 DEGREE TIP

CROWN P/N: 20810 **NAME:** CENTURY **OEM P/N:** 103068-4 1/2
MODELS: UNKNOWN

CROWN P/N: 20781 **NAME:** CARLIN **OEM P/N:** A280 **MODELS:** 98 102, 100-101, 200-201 & 301 CRD
 1/16" DIA. ROD WITH BB

CROWN P/N: 20820
NAME: CHICAGO EASTERN
OEM P/N: P10129 & 28
MODELS: RING BURNERS

CROWN P/N: 20782 **NAME:** CARLIN **OEM P/N:** A457
MODELS: 99FRD 1/16" DIA ROD WITH BB

CROWN P/N: 20850 **NAME:** CHRYSLER **OEM P/N:** 1025759
MODELS: UNKNOWN

CROWN P/N: 20786 **NAME:** CARLIN **OEM P/N:** 76141
MODELS: ELITE BURNER WITH 5" AIR TUBE 2 1/2" BB

CROWN P/N: 20872 **NAME:** CLEAN BURN **OEM P/N:** 33183
MODELS: UNKNOWN - PROPRIETARY CONTACT CLEAN BURN

CROWN P/N: 20787 **NAME:** CARLIN **OEM P/N:** 76158
MODELS: ELITE BURNER WITH 7" AIR TUBE 4 1/2" BB

CROWN P/N: 20874
NAME: CLEAN BURN
OEM P/N: 33085 & 33086
MODELS: UNKNOWN

CROWN P/N: 20788 **NAME:** CARLIN **OEM P/N:** 76166
MODELS: ELITE BURNER WITH 9" AIR TUBE 6 1/2" BB

CROWN P/N: 20876 **NAME:** CLEAN BURN **OEM P/N:** 33109 REV 2 & 33108
MODELS: CB-2000

CROWN P/N: 20762 **NAME:** CARLIN **OEM P/N:** 76174
MODELS: ELITE BURNER WITH 11" AIR TUBE 8 1/2" BB

CROWN P/N: 20900 **NAME:** CLEAVER-BROOKS **OEM P/N:** 94-20
MODELS: UNKNOWN

CROWN P/N: 20795 **NAME:** CENTURY **OEM P/N:** 54991
MODELS: UNKNOWN

CROWN P/N: 20905 **NAME:** CLEAVER-BROOKS **OEM P/N:** 94-A-179-1
MODELS: UNKNOWN

CROWN P/N: 20805 **NAME:** CENTURY **OEM P/N:** 103068-4
MODELS: UNKNOWN

CROWN P/N: 20910 **NAME:** CLEAVER-BROOKS **OEM P/N:** 435-65
MODELS: P & M 25 TO 40

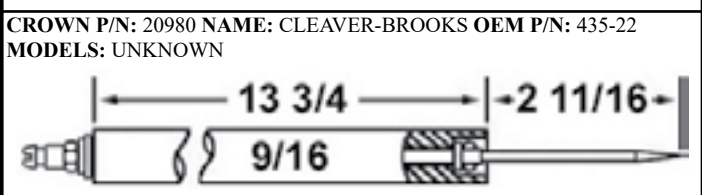
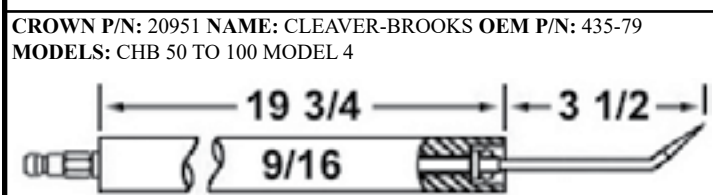
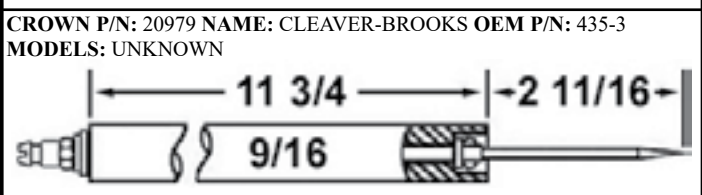
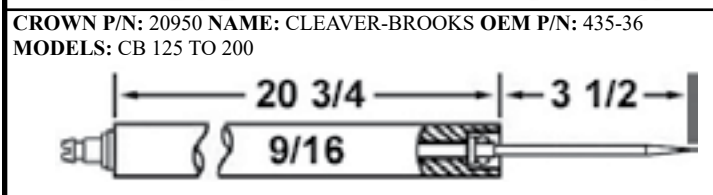
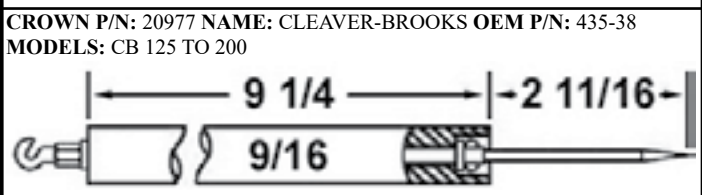
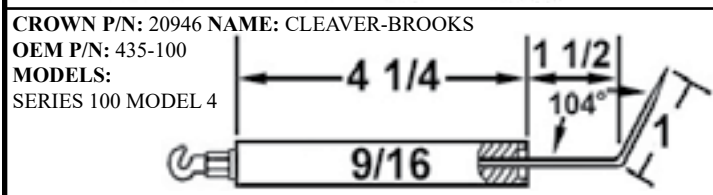
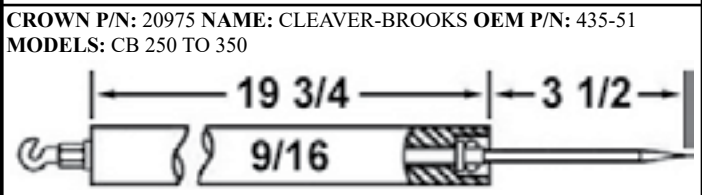
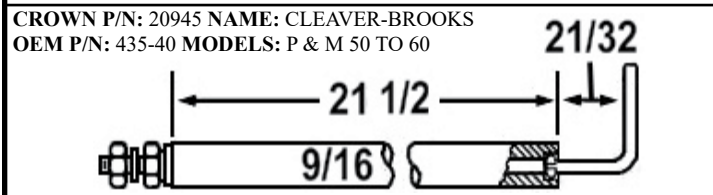
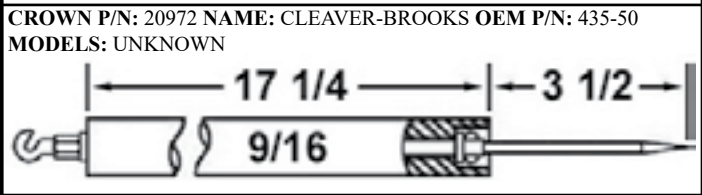
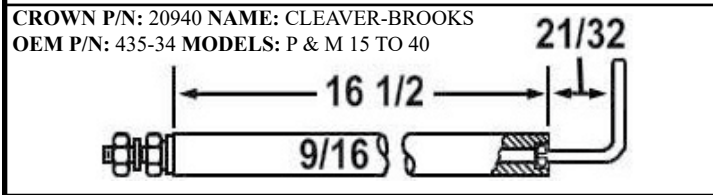
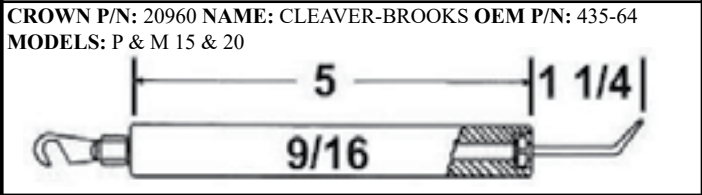
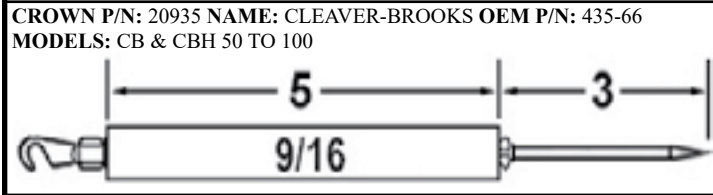
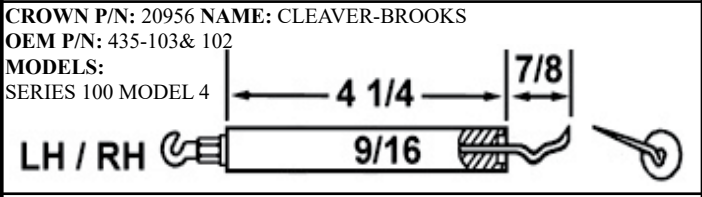
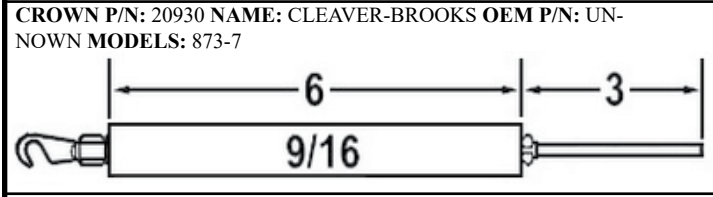
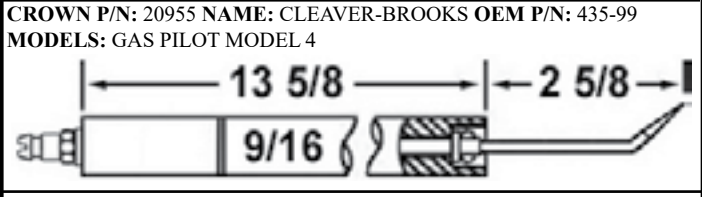
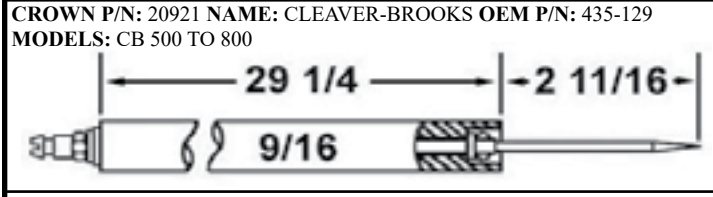
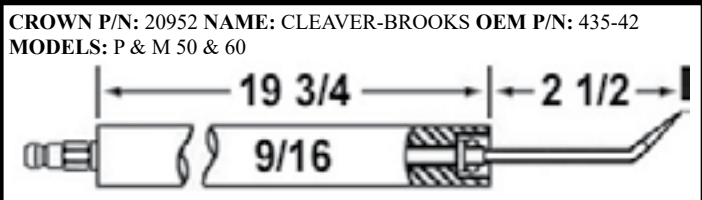
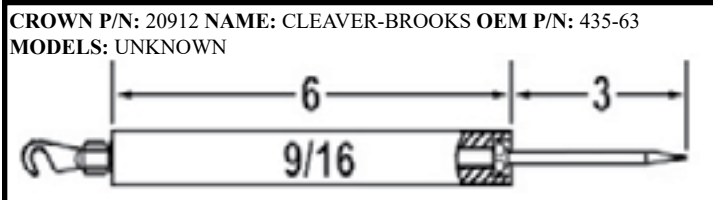



Section 1: Electrodes

CROWN P/N: 20982 NAME: CLEAVER-BROOKS OEM P/N: 435-74
MODELS: UNKNOWN

CROWN P/N: 21013 NAME: COLEMAN OEM P/N: 8870-420
MODELS: UNKNOWN

CROWN P/N: 20984 NAME: CLEAVER-BROOKS OEM P/N: 435-78
MODELS: UNKNOWN

CROWN P/N: 21025 NAME: COLUMBIA BOILER
OEM P/N: UNKNOWN MODELS: UNKNOWN

CROWN P/N: 20986 NAME: CLEAVER-BROOKS OEM P/N: 435-52
MODELS: UNKNOWN

CROWN P/N: 21046 NAME: COX OEM P/N: UNKNOWN
MODELS: UNKNOWN

CROWN P/N: 20989 NAME: CLEAVER-BROOKS OEM P/N: 435-71
MODELS: UNKNOWN

CROWN P/N: 21050 NAME: CRANE OEM P/N: UNKNOWN
MODELS: CFR OIL BURNER

CROWN P/N: 20990 NAME: CLEAVER-BROOKS OEM P/N: 435-23
MODELS: UNKNOWN

CROWN P/N: 21060 NAME: CROWN OEM P/N: UNKNOWN
MODELS: UNKNOWN

CROWN P/N: 20992 NAME: CLEAVER-BROOKS OEM P/N: 435-11
MODELS: CPT

CROWN P/N: 21065 NAME: CROWN OEM P/N: UNKNOWN
MODELS: UNKNOWN

CROWN P/N: 20995 NAME: CLEAVER-BROOKS OEM P/N: 873-69
MODELS: ALL 2-7

CROWN P/N: 21105 NAME: DELCO OEM P/N: UNKNOWN
MODELS: UNKNOWN

CROWN P/N: 20996 NAME: CLEAVER-BROOKS OEM P/N: 873-70
MODELS: AME & AMGE 5 & 60

CROWN P/N: 21115 NAME: DELCO OEM P/N: 509146
MODELS: UNKNOWN

CROWN P/N: 21010 NAME: COLEMAN OEM P/N: 4070-410
MODELS: UNKNOWN

CROWN P/N: 21155 NAME: DELCO OEM P/N: 5083431
MODELS: UNKNOWN

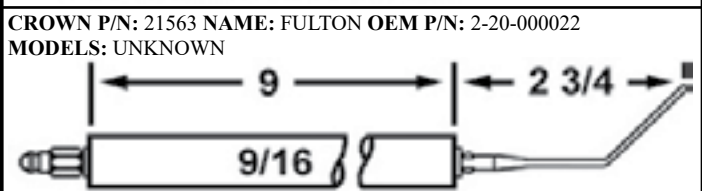
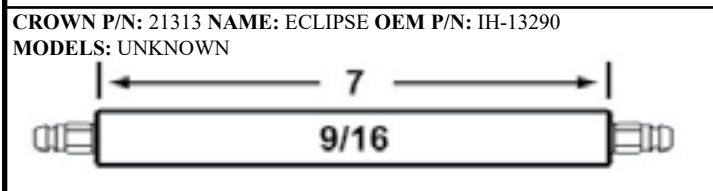
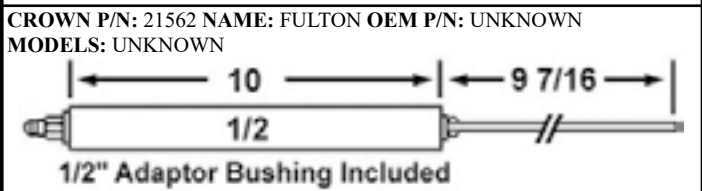
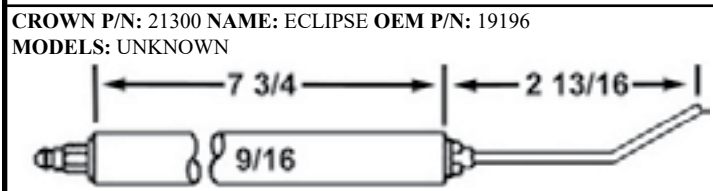
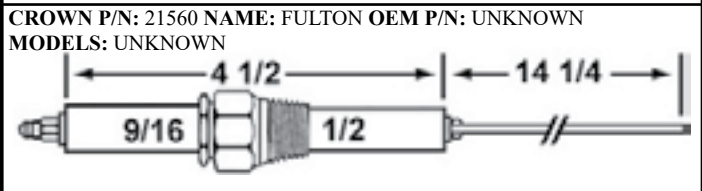
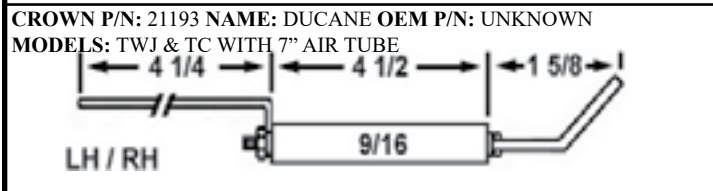
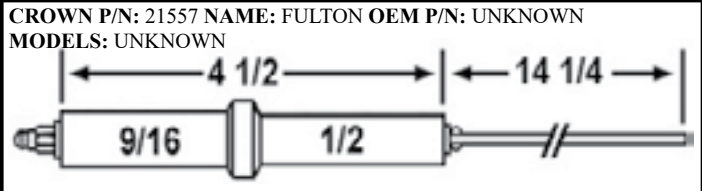
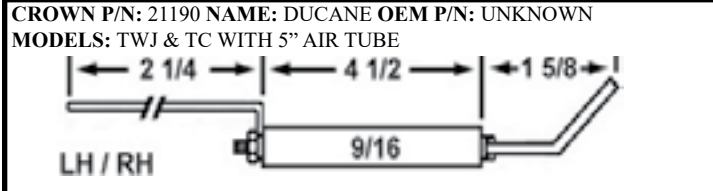
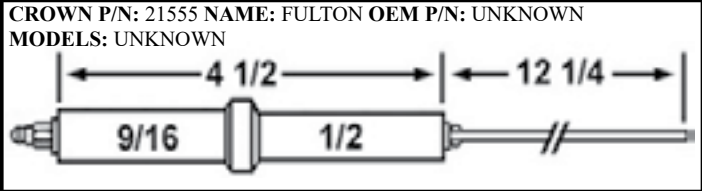
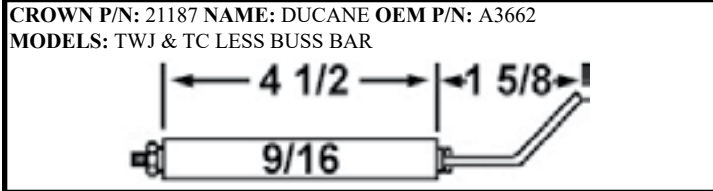
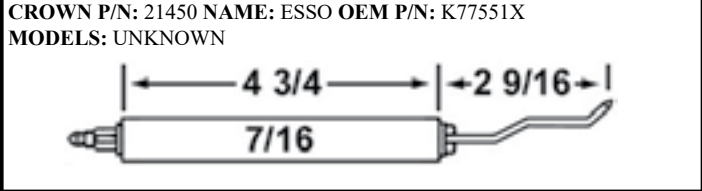
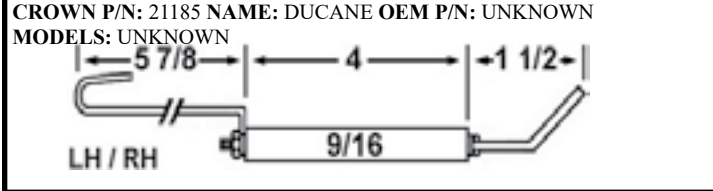
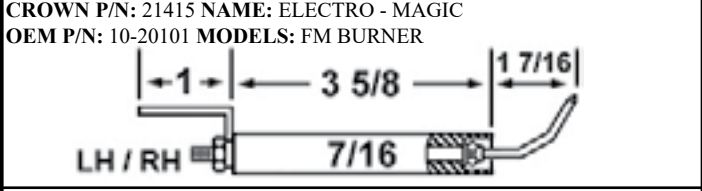
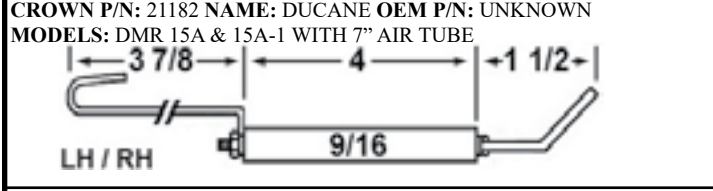
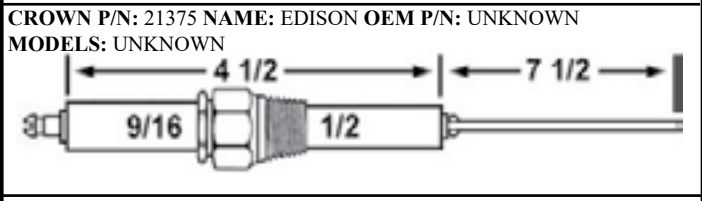
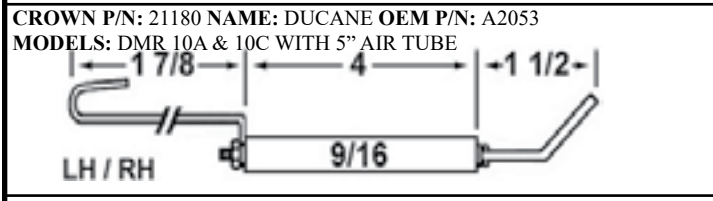
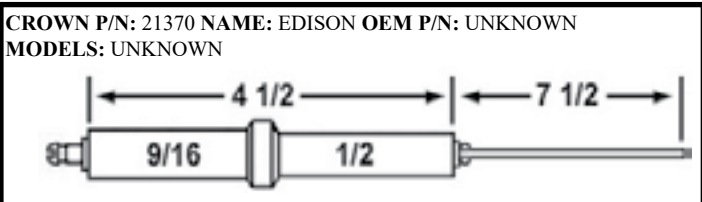
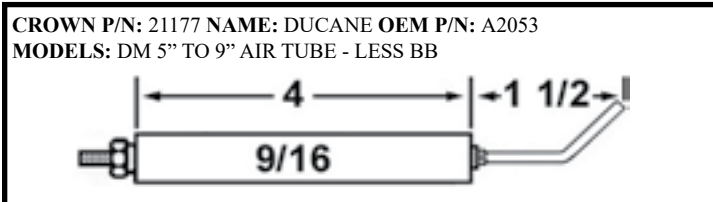



Section 1: Electrodes

<p>CROWN P/N: 21565 NAME: FULTON OEM P/N: 2-20-000021 MODELS: UNKNOWN</p>	<p>CROWN P/N: 21655 NAME: GENERAL OIL OEM P/N: UNKNOWN MODELS: UNKNOWN</p>
<p>CROWN P/N: 21566 NAME: FULTON OEM P/N: 2-20-000043 MODELS: A & H</p>	<p>CROWN P/N: 21672 NAME: GORDON - PIATT OEM P/N: 921000-3500 MODELS: GP-216C PILOT FOR 5 1/2" & 8" AIR TUBE</p>
<p>CROWN P/N: 21570 NAME: FULTON OEM P/N: 2-20-000054 MODELS: UNKNOWN</p>	<p>CROWN P/N: 21674 NAME: GORDON - PIATT OEM P/N: 921000-3510 MODELS: GP-216C PILOT FOR 12" AIR TUBE</p>
<p>CROWN P/N: 21571 NAME: FULTON OEM P/N: 2-20-000071 MODELS: UNKNOWN</p>	<p>CROWN P/N: 21677 NAME: GORDON - PIATT OEM P/N: 210059-0000 MODELS: UNKNOWN</p>
<p>CROWN P/N: 21573 NAME: FULTON OEM P/N: 2-20-000069 MODELS: UNKNOWN</p>	<p>CROWN P/N: 21681 NAME: GORDON - PIATT OEM P/N: 210049-0000-50-0000 MODELS: RL & RLS JACOBS</p>
<p>CROWN P/N: 21610 NAME: GENERAL ELECTRIC OEM P/N: K-5703668AB MODELS: UNKNOWN</p>	<p>CROWN P/N: 21683 NAME: GORDON - PIATT OEM P/N: UNKNOWN MODELS: F7T</p>
<p>CROWN P/N: 21615 NAME: GENERAL ELECTRIC OEM P/N: K-5703668AB MODELS: UNKNOWN</p>	<p>CROWN P/N: 21687 NAME: GORDON - PIATT OEM P/N: 280038 MODELS: 210036-1 FOR 4" AIR TUBE</p>
<p>CROWN P/N: 21617 NAME: GENERAL ELECTRIC OEM P/N: V-5700834AC MODELS: ASM</p>	<p>CROWN P/N: 21689 NAME: GORDON - PIATT OEM P/N: 210036-0003 MODELS: 210036-3/5 FOR 2" AIR TUBE</p>
<p>CROWN P/N: 21625 NAME: GENERAL ELECTRIC OEM P/N: K-5705183AD MODELS: UNKNOWN</p>	<p>CROWN P/N: 21690 NAME: GORDON - PIATT OEM P/N: 210036-0002 MODELS: 210036-2 FOR 8" AIR TUBE</p>

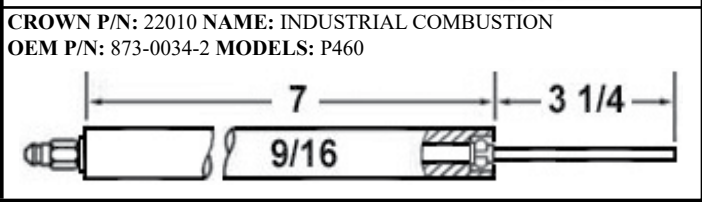
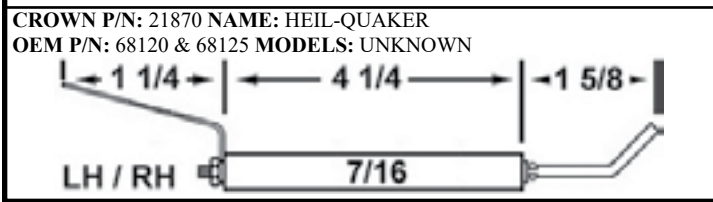
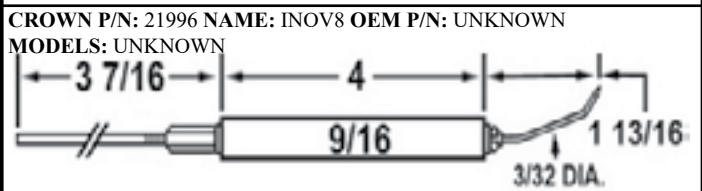
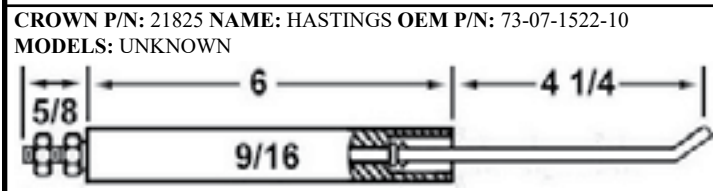
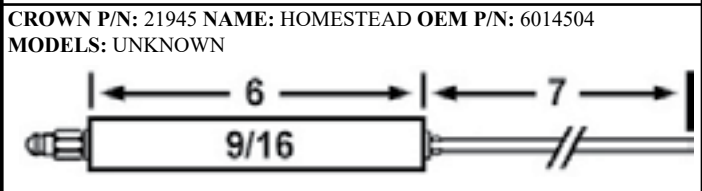
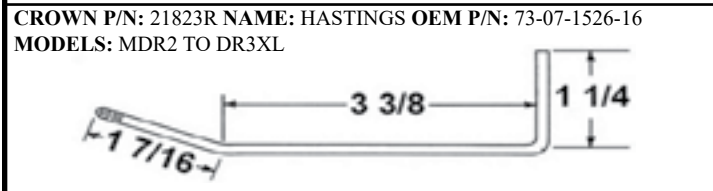
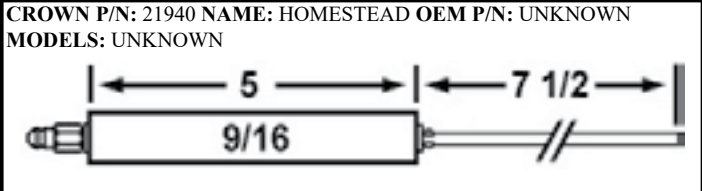
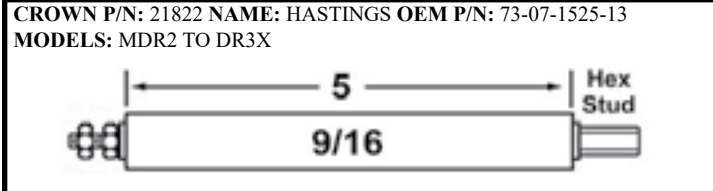
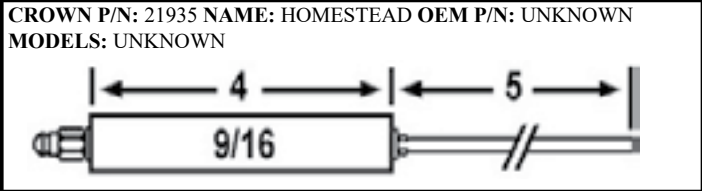
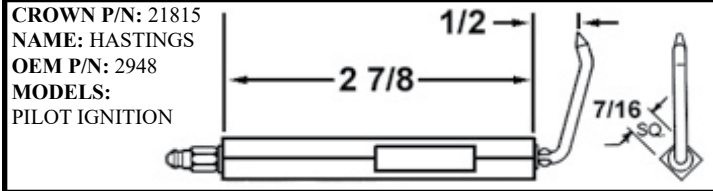
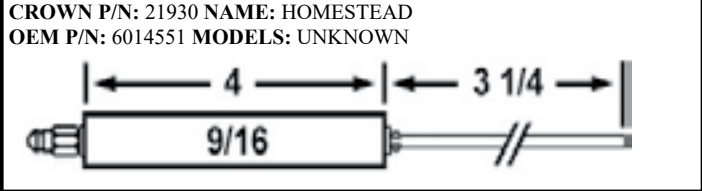
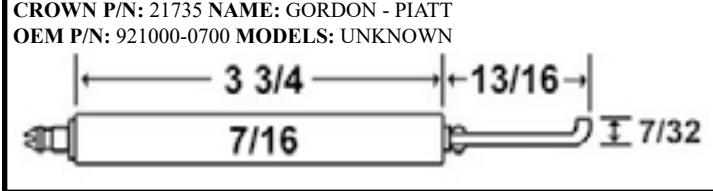
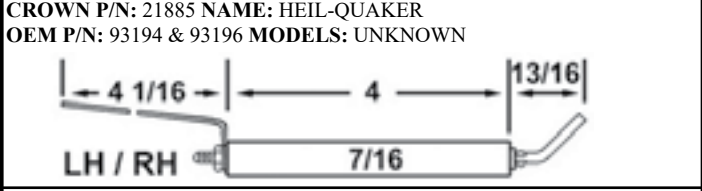
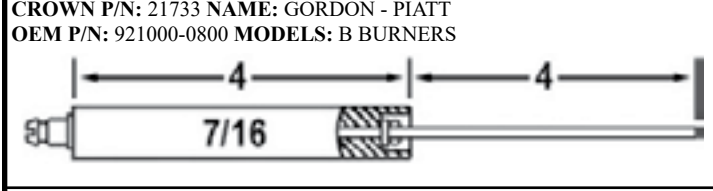
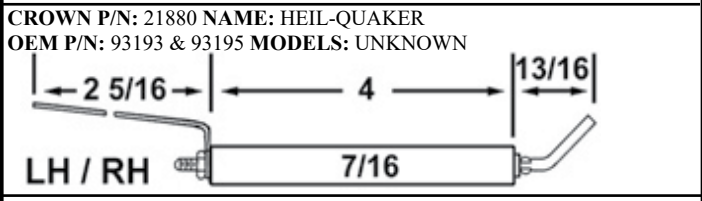
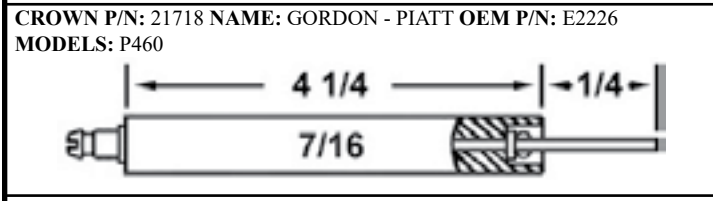
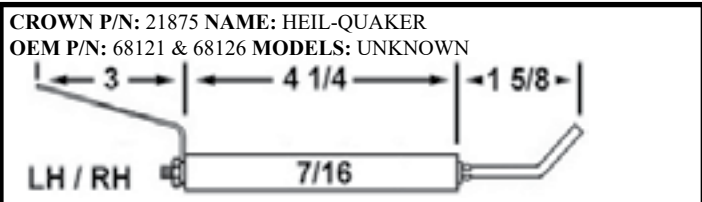
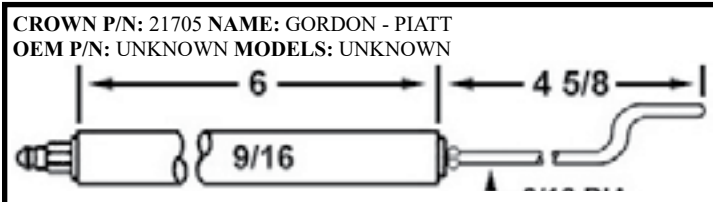

CROWN P/N: 22013-01 **NAME:** INDUSTRIAL COMBUSTION
OEM P/N: 873-108
MODELS: CB PROFIRE #1 & #2. D & MARC

7
7/16
1 3/4

CROWN P/N: 22083
NAME: IRON FIREMAN
OEM P/N: 135161 & 135162
MODELS: UNKNOWN

6
3/4
9/16
LH / RH

CROWN P/N: 22015 **NAME:** INDUSTRIAL COMBUSTION
OEM P/N: 873-501-2 **MODELS:** SC 55 & 65

4 1/2
29/64
9/16

CROWN P/N: 22087 **NAME:** IRON FIREMAN **OEM P/N:** 134259 & 34260 **MODELS:** UNKNOWN

1 3/8
5
3/4
9/16
LH / RH

CROWN P/N: 22016 **NAME:** INDUSTRIAL COMBUSTION
OEM P/N: 873-76-2 **MODELS:** SC-55 FLAME ROD

4
5 15/16
3/16 DIA. ROD
9/16

CROWN P/N: 22088
NAME: IRON FIREMAN
OEM P/N: 141833 & 141834
MODELS: UNKNOWN

1 3/8
5
1 3/16
9/16
LH / RH

CROWN P/N: 22017 **NAME:** INDUSTRIAL COMBUSTION
OEM P/N: 873-508
MODELS: D SERIES 28-300, FG, FMG, FGL, & FMGL

7
1 3/4
9/16

CROWN P/N: 22090 **NAME:** IRON FIREMAN
OEM P/N: 136159 & 136160 **MODELS:** UNKNOWN

1 3/8
5
1 9/16
9/16
LH / RH

CROWN P/N: 22020 **NAME:** INDUSTRIAL COMBUSTION
OEM P/N: 873-0092-00 **MODELS:** FP & MP BURNERS

7 1/4
REPLACED BY P/N: XX1597

CROWN P/N: 22092
NAME: IRON FIREMAN
OEM P/N: 149280-G01
MODELS: UNKNOWN

2 7/8
5
2 7/8
9/16
11/16

CROWN P/N: 22021 **NAME:** INDUSTRIAL COMBUSTION
OEM P/N: 873-0087-00 **MODELS:** D & MARC BURNERS

7
1 3/4
9/16
3/32 DIA.

CROWN P/N: 22095 **NAME:** IRON FIREMAN **OEM P/N:** 149280-G02
MODELS: UNKNOWN

2 7/8
5
1 5/8
9/16
1 1/32

CROWN P/N: 22025
NAME: INTERBURNER
OEM P/N: 26950
MODELS: UNKNOWN

3 1/16
-1-
.12 GAP
.43

CROWN P/N: 22098 **NAME:** IRON FIREMAN **OEM P/N:** 149281-G01
MODELS: UNKNOWN

5
2 7/8
11/16
9/16

CROWN P/N: 22046 **NAME:** IRON FIREMAN **OEM P/N:** 149280-G03
MODELS: UNKNOWN

2 7/8
5
1 5/8
3/4
9/16

CROWN P/N: 22105 **NAME:** IRON FIREMAN **OEM P/N:** 137555
MODELS: AO 142059

5
7/8
5/8
9/16

CROWN P/N: 22070 **NAME:** IRON FIREMAN **OEM P/N:** UNKNOWN
MODELS: UNKNOWN

6
3/4
9/16
LH / RH

CROWN P/N: 22115 **NAME:** IRON FIREMAN **OEM P/N:** 137161
MODELS: UNKNOWN

1 3/8
5
2
9/16

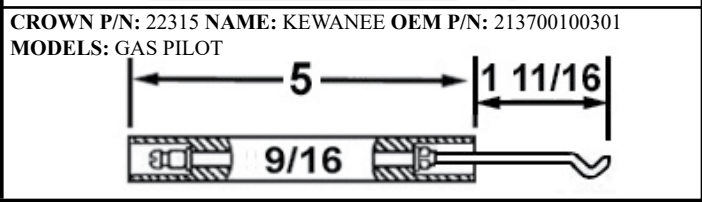
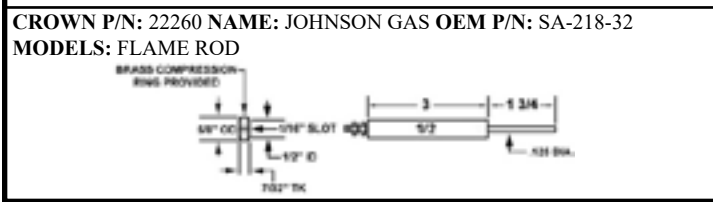
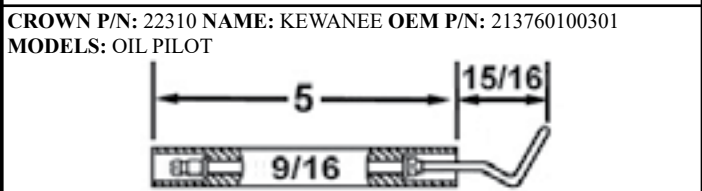
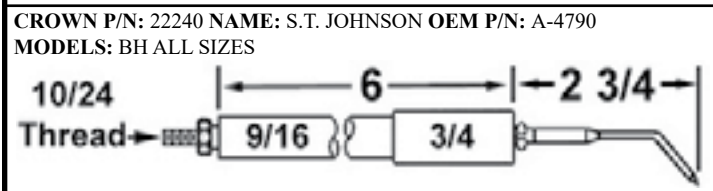
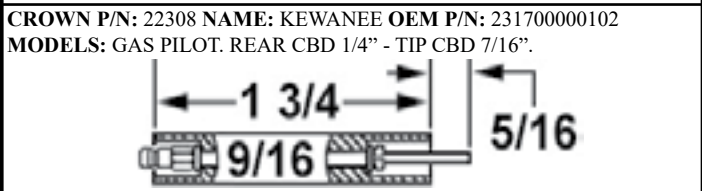
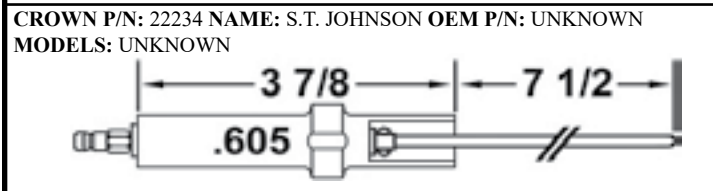
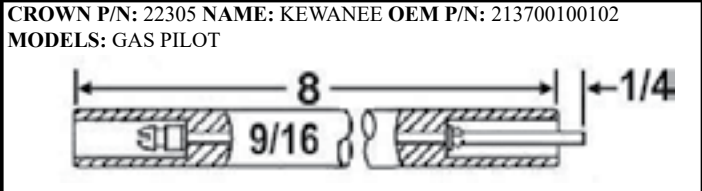
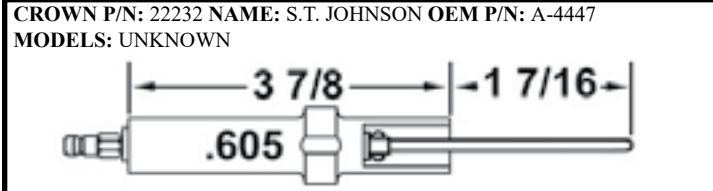
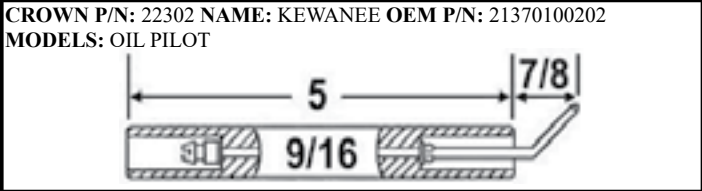
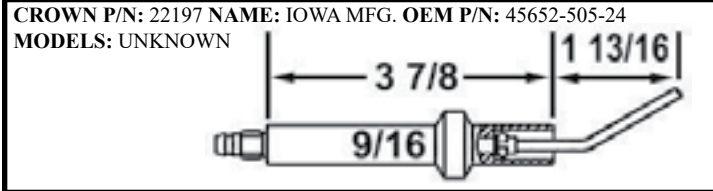
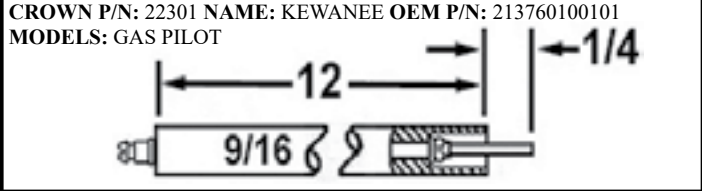
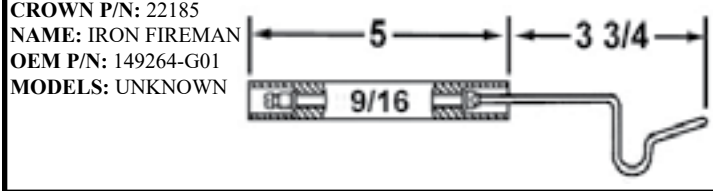
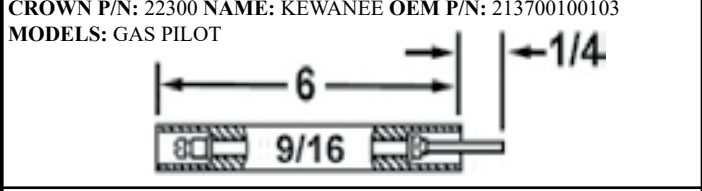
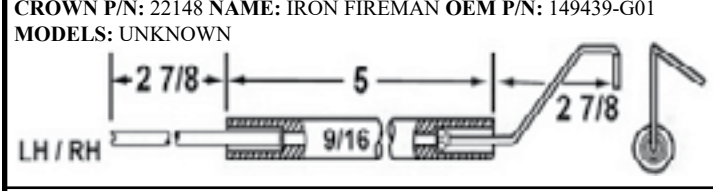
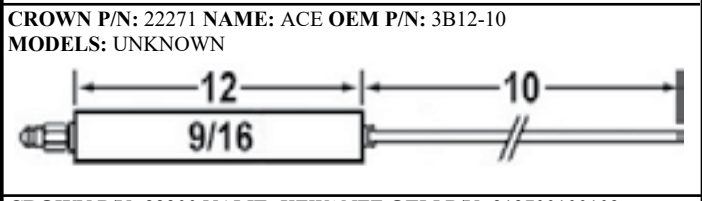
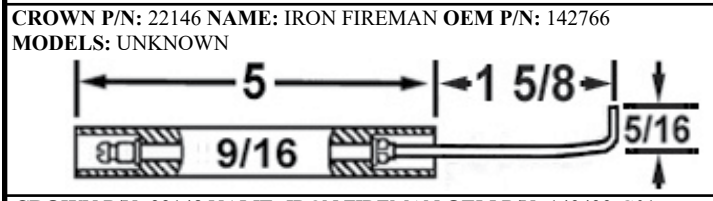
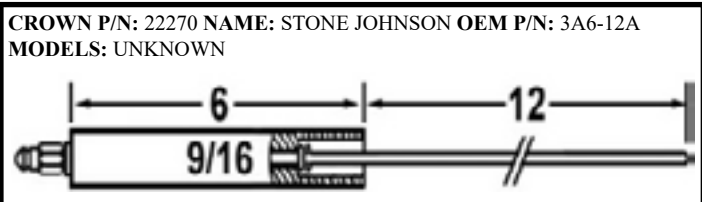
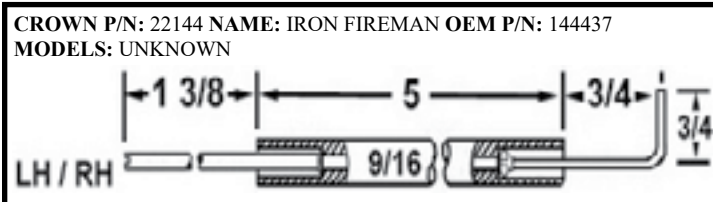



Section 1: Electrodes

CROWN P/N: 22316 **NAME:** KEWANEE **OEM P/N:** 213790070901
MODELS: 2 TO 5 BURNER

CROWN P/N: 22428 **NAME:** LENNOX **OEM P/N:** 51A9401 & 301
MODELS: UNKNOWN

CROWN P/N: 22317 **NAME:** KEWANEE **OEM P/N:** 213790070902
MODELS: 6 & 7 BURNER

CROWN P/N: 22429 **NAME:** LENNOX **OEM P/N:** P-8-5798
MODELS: GAS BUSS ROD

CROWN P/N: 22320 **NAME:** KEWANEE **OEM P/N:** 950525-2
MODELS: UNKNOWN

CROWN P/N: 22434 **NAME:** LENNOX **OEM P/N:** 77C8301
MODELS: SENSOR

CROWN P/N: 22326 **NAME:** KEWANEE **OEM P/N:** 309200000002
MODELS: UNKNOWN

CROWN P/N: 22435 **NAME:** LENNOX **OEM P/N:** 77C8201
MODELS: IGNITER

CROWN P/N: 22407 **NAME:** LANDA **OEM P/N:** 7-9005
MODELS: UNKNOWN

CROWN P/N: 22463 **NAME:** LOCHINVAR **OEM P/N:** RLY-2705
MODELS: POWER FIN - .250 X .031 MALE QUICK CONNECT TAB.

CROWN P/N: 22408 **NAME:** LANAIR **OEM P/N:** 8737 & 8738
MODELS: UNKNOWN

CROWN P/N: 22480 **NAME:** LYNN **OEM P/N:** UNKNOWN
MODELS: UNKNOWN

CROWN P/N: 22409 **NAME:** LANAIR **OEM P/N:** 8945 & 8944
MODELS: UNKNOWN

CROWN P/N: 25005 **NAME:** McQUAY **OEM P/N:** 357410-A-00
MODELS: UNKNOWN

CROWN P/N: 22426 **NAME:** LENNOX **OEM P/N:** P-8-7038
MODELS: UNKNOWN

CROWN P/N: 25006 **NAME:** McQUAY **OEM P/N:** 365577-A-00
MODELS: UNKNOWN

CROWN P/N: 22427 **NAME:** LENNOX **OEM P/N:** P-8-5784
MODELS: UNKNOWN

CROWN P/N: 25025 **NAME:** MALSBARO **OEM P/N:** 821669
MODELS: UNKNOWN



<p>CROWN P/N: 25045 NAME: MARSDEN OEM P/N: 179118 MODELS: UNKNOWN</p>	<p>CROWN P/N: 25150 NAME: MIDCO OEM P/N: 1341-00 MODELS: ADAPTO PILOT FLAME ROD</p>
<p>CROWN P/N: 25047 NAME: MARSDEN OEM P/N: 25047-F3 MODELS: UNKNOWN</p>	<p>CROWN P/N: 25151 NAME: MIDCO OEM P/N: UNKNOWN MODELS: ADAPTO PILOT FLAME ROD</p>
<p>CROWN P/N: 25052 NAME: MASTER VIBRATOR OEM P/N: M-8989 & 8990 MODELS: UNKNOWN</p>	<p>CROWN P/N: 25152 NAME: MIDCO OEM P/N: 1342-00 MODELS: PILOT SPARK ROD FOR HMA 1 & 2 BURNERS</p>
<p>CROWN P/N: 25054 NAME: MASTER VIBRATOR OEM P/N: M-12951 & 12952 MODELS: BB HEATER 64-65 120MBTU</p>	<p>CROWN P/N: 25156 NAME: MIDCO OEM P/N: 5234-50 MODELS: FLAME ROD FOR ECONOMITE 400 SERIES BURNERS</p>
<p>CROWN P/N: 25058 NAME: MASTER VIBRATOR OEM P/N: M3987 REV H MODELS: HIGH PRESSURE HEATERS</p>	<p>CROWN P/N: 25158 NAME: MIDCO OEM P/N: 5249-32 MODELS: IGNITER FOR ECONOMITE 400 SERIES BURNERS</p>
<p>CROWN P/N: 25060 NAME: MASTER VIBRATOR OEM P/N: M3987 REV J MODELS: HIGH PRESSURE HEATERS</p>	<p>CROWN P/N: 25168 NAME: MIDCO OEM P/N: 6430-00 MODELS: JDS ELECTRODE</p>
<p>CROWN P/N: 25095 NAME: METAL MASTER OEM P/N: A-1031-217 MODELS: UNKNOWN</p>	<p>CROWN P/N: 25177 NAME: MIDCO OEM P/N: 6725-50 MODELS: UNIMITE SPARK ROD</p>
<p>CROWN P/N: 25107 NAME: METAL MASTER OEM P/N: UNKNOWN MODELS: UNKNOWN</p>	<p>CROWN P/N: 25180 NAME: MIDCO OEM P/N: 7171-00 MODELS: UNKNOWN</p>
<p>CROWN P/N: 25149 NAME: MIDCO OEM P/N: 1360-03 MODELS: FLAME ROD FOR HMA 1 & 2 BURNERS USED WITH 25152</p>	<p>CROWN P/N: 25184 NAME: MIDCO OEM P/N: 6011-20 MODELS: 232 SPARK ROD ASSEMBLY</p>



Section 1: Electrodes

CROWN P/N: 25190 **NAME:** MIDCO **OEM P/N:** 3713-71
MODELS: NHL PILOT

CROWN P/N: 25218 **NAME:** M. HONEYWELL
OEM P/N: UNKNOWN **MODELS:** UNKNOWN

CROWN P/N: 25193 **OEM NAME:** MIDCO **OEM P/N:** 7124-40
MODELS: AG FLAME ROD

CROWN P/N: 25220 **NAME:** M. HONEYWELL
OEM P/N: UNKNOWN **MODELS:** UNKNOWN

CROWN P/N: 35161 **OEM NAME:** MIDCO **OEM P/N:** 6457-00
MODELS: J82 / 83-DS

CROWN P/N: 25221 **NAME:** M. HONEYWELL
OEM P/N: UNKNOWN **MODELS:** UNKNOWN

CROWN P/N: 35192 **NAME:** MIDCO **OEM P/N:** 6717-00
MODELS: UNKNOWN

CROWN P/N: 25222 **NAME:** M. HONEYWELL
OEM P/N: UNKNOWN **MODELS:** UNKNOWN

CROWN P/N: 35199 **NAME:** MIDCO **OEM P/N:** 6418-00
MODELS: J82 / 83-DS

CROWN P/N: 25210 **NAME:** MILLER **OEM P/N:** E-1622-B
MODELS: USED ON H-3512-A

CROWN P/N: 25226 **NAME:** M. HONEYWELL
OEM P/N: UNKNOWN **MODELS:** ADAPTO PILOT SPARK ROD

CROWN P/N: 25212 **NAME:** MILLER **OEM P/N:** 308-0550
MODELS: FS MODEL

CROWN P/N: 25215 **NAME:** M. HONEYWELL
OEM P/N: UNKNOWN **MODELS:** UNKNOWN

CROWN P/N: 25230
NAME: M. HONEYWELL
OEM P/N: UNKNOWN **MODELS:** UNKNOWN

CROWN P/N: 25216
NAME: M. HONEYWELL
OEM P/N: UNKNOWN **MODELS:** UNKNOWN

CROWN P/N: 25412 **NAME:** NATIONAL AIROIL
OEM P/N: UNKNOWN **MODELS:** UNKNOWN

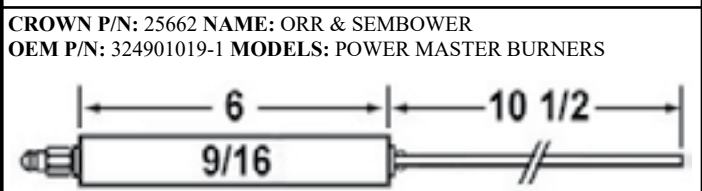
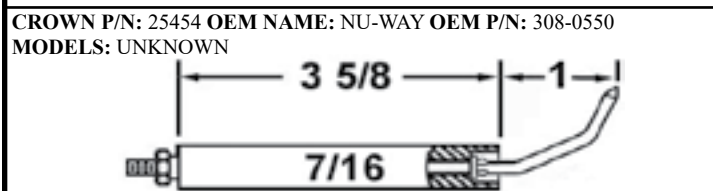
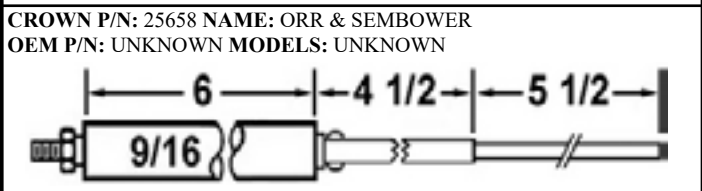
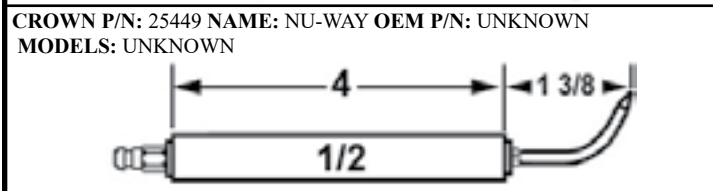
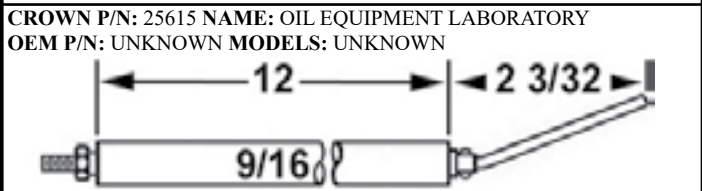
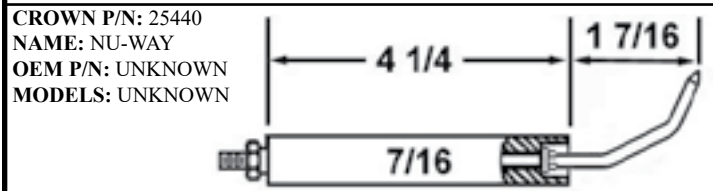
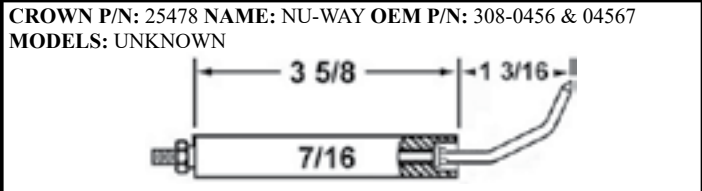
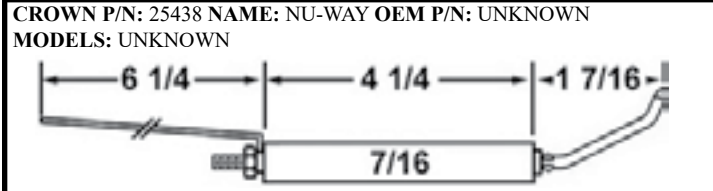
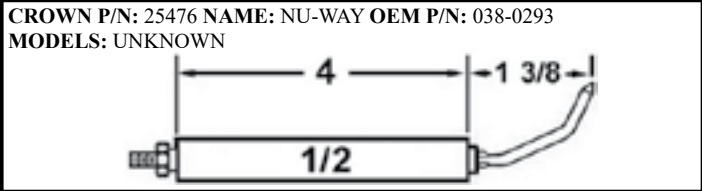
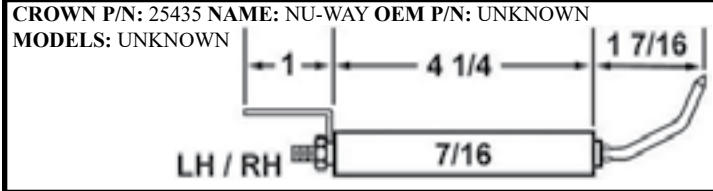
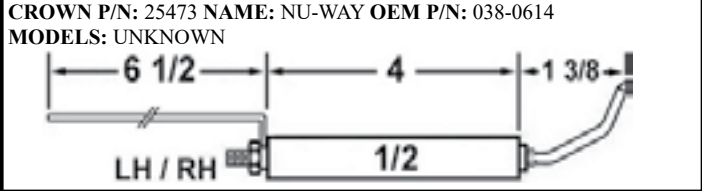
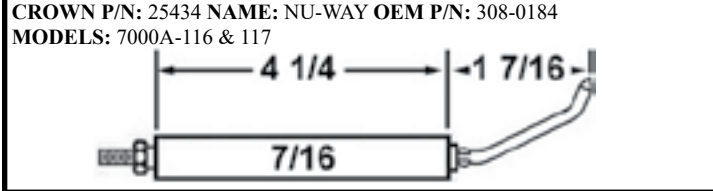
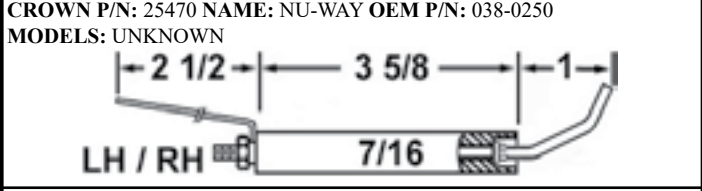
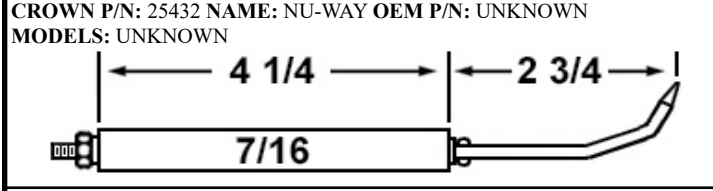
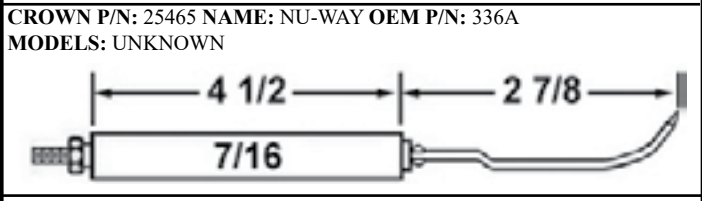
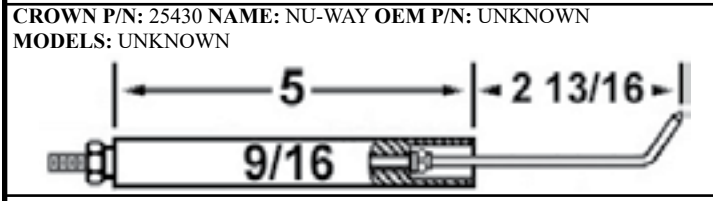
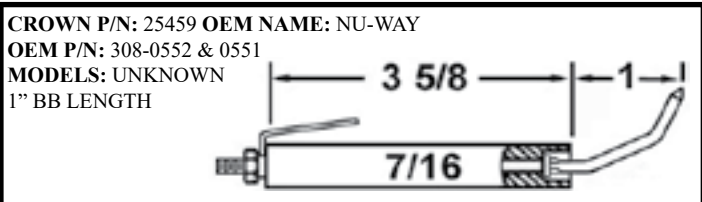
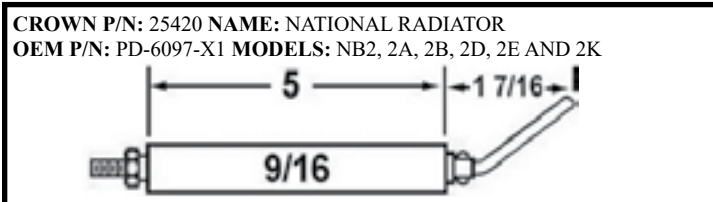



Section 1: Electrodes

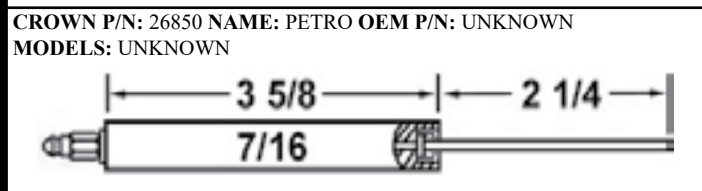
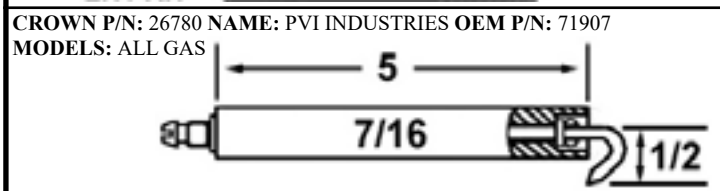
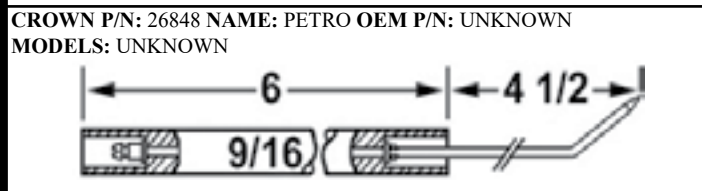
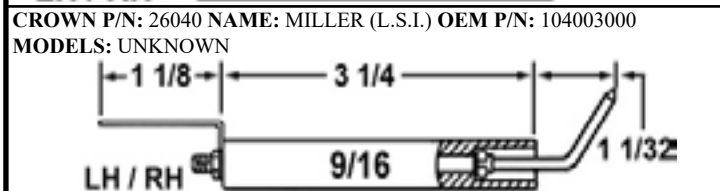
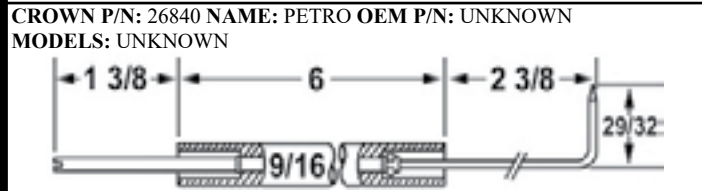
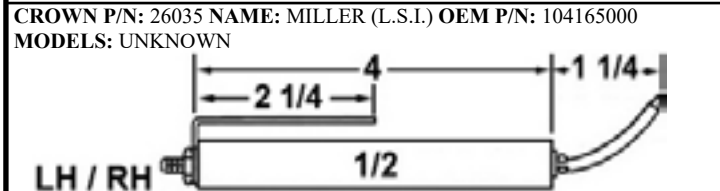
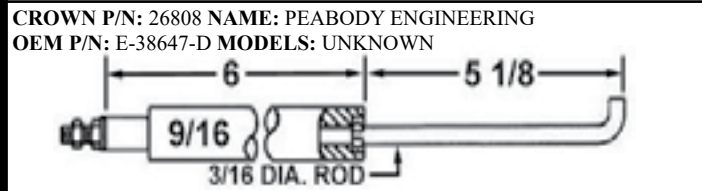
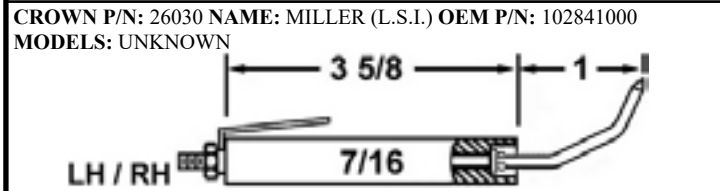
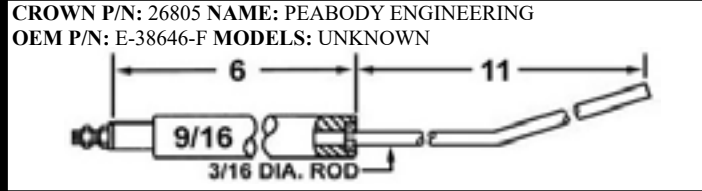
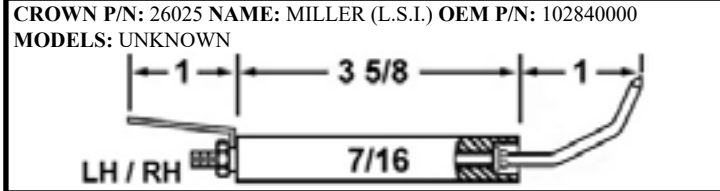
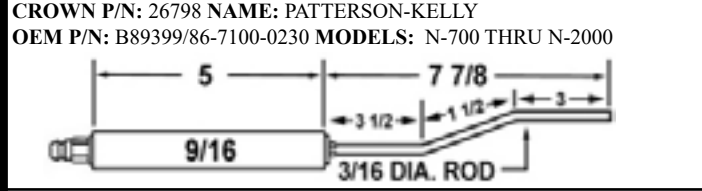
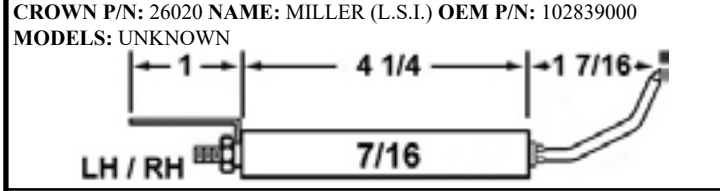
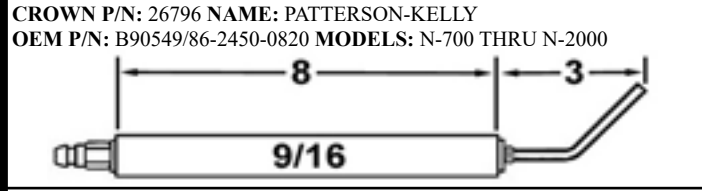
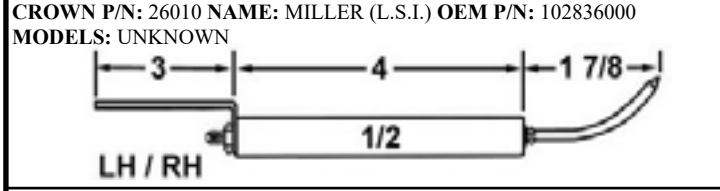
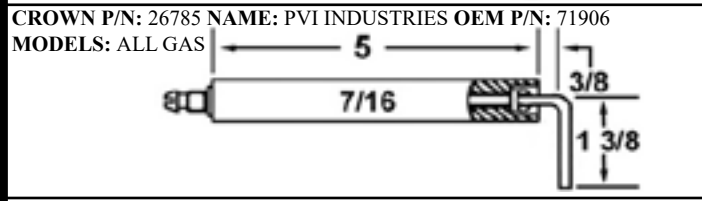
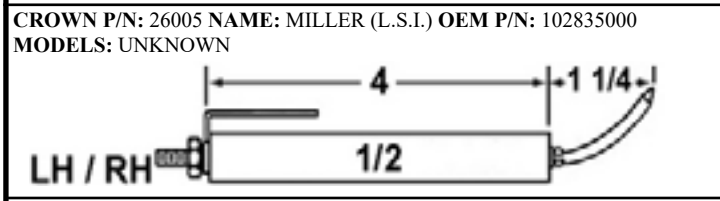
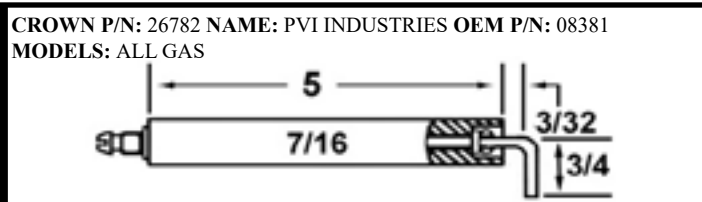
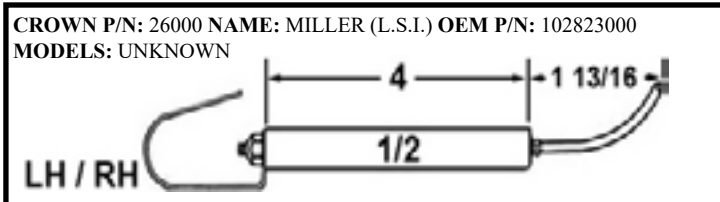



CROWN P/N: 26856 **NAME:** PETRO **OEM P/N:** C114049
MODELS: UNKNOWN

CROWN P/N: 26878 **NAME:** POWERFLAME **OEM P/N:** UNKNOWN
MODELS: UNKNOWN

CROWN P/N: 26859 **NAME:** PETRO **OEM P/N:** UNKNOWN
MODELS: UNKNOWN

CROWN P/N: 26880 **NAME:** POWERFLAME **OEM P/N:** M775
MODELS: FGO & FM-1 IGNITOR

CROWN P/N: 26860 **NAME:** PETRO **OEM P/N:** UNKNOWN
MODELS: W1 TO W10

CROWN P/N: 26882 **NAME:** POWERFLAME **OEM P/N:** M775
MODELS: FGO & FM-1 GAS PILOT

CROWN P/N: 26865 **NAME:** PETRO **OEM P/N:** UNKNOWN
MODELS: UNKNOWN

CROWN P/N: 26884 **NAME:** POWERFLAME **OEM P/N:** M-775
MODELS: FGO-FM-1 GAS PILOT

CROWN P/N: 26866 **NAME:** PETRO **OEM P/N:** UNKNOWN
MODELS: UNKNOWN

CROWN P/N: 26887 **NAME:** POWERFLAME **OEM P/N:** X04210
MODELS: C, J, & CG

CROWN P/N: 26867 **NAME:** PETRO **OEM P/N:** UNKNOWN
MODELS: UNKNOWN

CROWN P/N: 26888 **NAME:** POWERFLAME **OEM P/N:** UNKNOWN
MODELS: UNKNOWN

CROWN P/N: 26871 **NAME:** POWERFLAME **OEM P/N:** 30D39-3 & 38-3
MODELS: UNKNOWN

CROWN P/N: 26890 **NAME:** POWERFLAME **OEM P/N:** UNKNOWN
MODELS: C, J, & CG

CROWN P/N: 26875 **NAME:** POWERFLAME **OEM P/N:** 126036
MODELS: P-90

CROWN P/N: 26892 **NAME:** POWERFLAME **OEM P/N:** X04248
MODELS: UNKNOWN

CROWN P/N: 26876 **NAME:** POWERFLAME **OEM P/N:** UNKNOWN
MODELS: UNKNOWN

CROWN P/N: 26893 **NAME:** POWERFLAME **OEM P/N:** X04220
MODELS: C2,C3, & C4 OIL BURNERS



Section 1: Electrodes

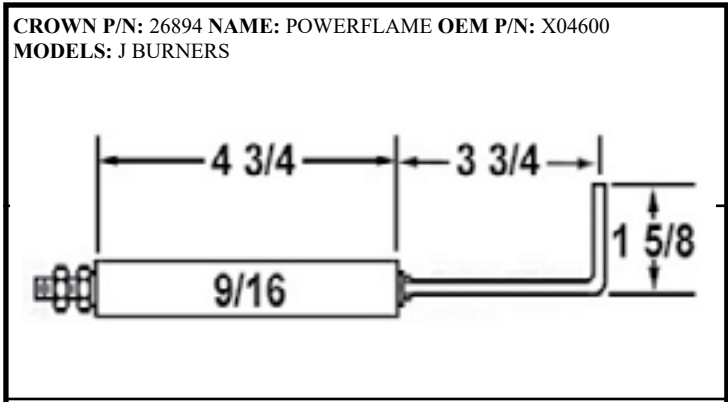

THIS SPACE LEFT BLANK INTENTIONALLY

THIS SPACE LEFT BLANK INTENTIONALLY

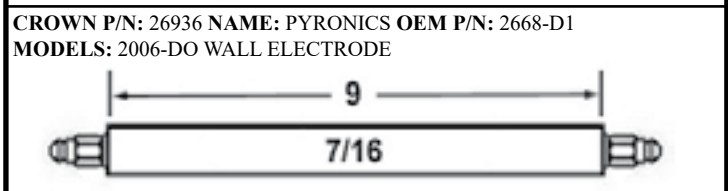
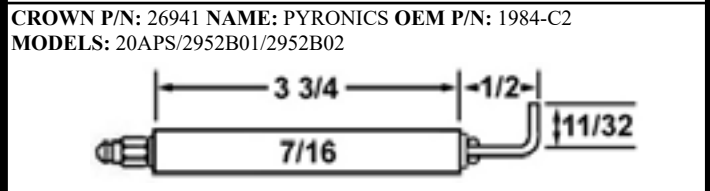
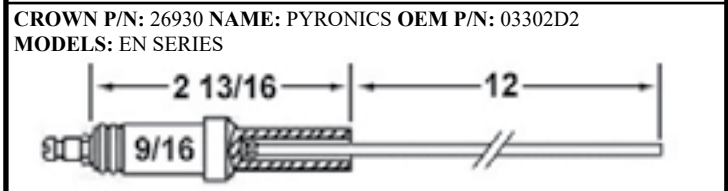
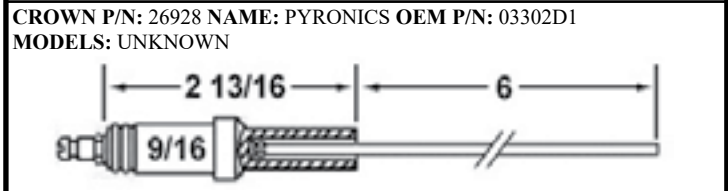
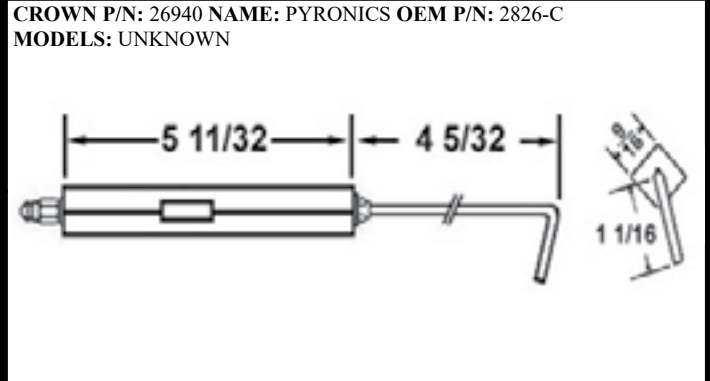
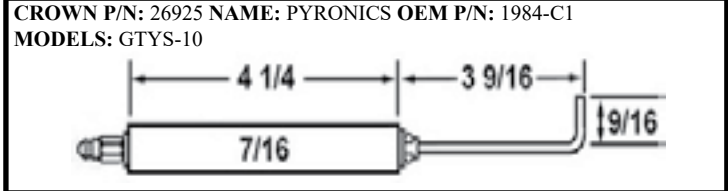
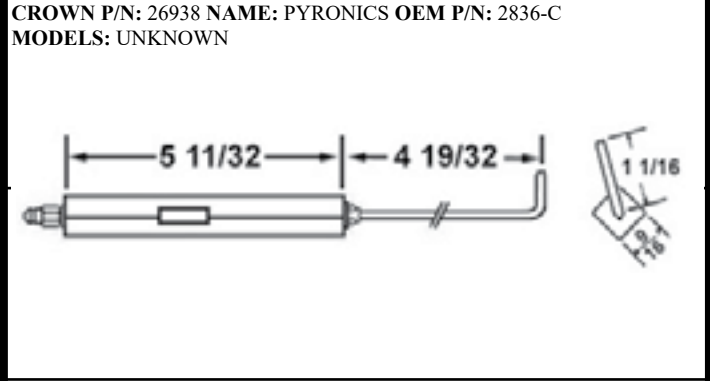
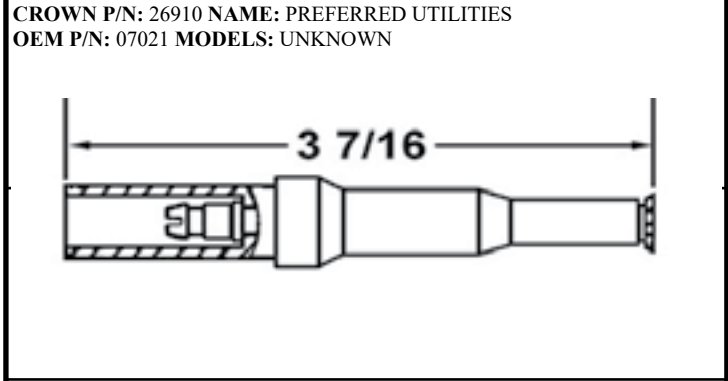

THIS SPACE LEFT BLANK INTENTIONALLY

THIS SPACE LEFT BLANK INTENTIONALLY

THIS SPACE LEFT BLANK INTENTIONALLY



<p>CROWN P/N: 26942 NAME: PYRONICS OEM P/N: 1984-C3 MODELS: 2952B01 & 02</p>	<p>CROWN P/N: 27170R NAME: RAY OIL BURNER OEM P/N: 50485 MODELS: PG, PGF, & MODEL 55</p>
<p>CROWN P/N: 27005 NAME: QUIET AUTOMATIC OEM P/N: UNKNOWN MODELS: UNKNOWN</p>	<p>CROWN P/N: 27172R NAME: RAY OIL BURNER OEM P/N: 51700 MODELS: P BURNERS</p>
<p>CROWN P/N: 27030 NAME: QUIET AUTOMATIC OEM P/N: UNKNOWN MODELS: UNKNOWN</p>	<p>CROWN P/N: 27250 NAME: ROSOEE OEM P/N: UNKNOWN MODELS: UNKNOWN</p>
<p>CROWN P/N: 27040 NAME: QUIET HEAT OEM P/N: E60601 MODELS: C100, 215, 265, 335, & D215, 319</p>	<p>CROWN P/N: 27321 NAME: SHELL HEAD OEM P/N: UNKNOWN MODELS: UNKNOWN</p>
<p>CROWN P/N: 27126 NAME: RAY OIL BURNER OEM P/N: 8214-1 MODELS: UNKNOWN</p>	<p>CROWN P/N: 27324 NAME: SHELL HEAD OEM P/N: UNKNOWN MODELS: UNKNOWN</p>
<p>CROWN P/N: 27132 NAME: RAY OIL BURNER OEM P/N: 8234-1 MODELS: 0-8 BOTTLED GAS</p>	<p>CROWN P/N: 27340 NAME: SHELL HEAD OEM P/N: UNKNOWN MODELS: UNKNOWN</p>
<p>CROWN P/N: 27140 NAME: RAY OIL BURNER OEM P/N: 51276-1 MODELS: JPE BURNER</p>	<p>CROWN P/N: 27342 NAME: SHELL HEAD OEM P/N: UNKNOWN MODELS: UNKNOWN</p>
<p>CROWN P/N: 27145 NAME: RAY OIL BURNER OEM P/N: 51703-1 MODELS: P BURNER</p>	<p>CROWN P/N: 27353 NAME: SHENANDOAH OEM P/N: 10155320 & 40 MODELS: WO-F</p>
<p>CROWN P/N: 27166 NAME: RAY OIL BURNER OEM P/N: 54110 MODELS: AE 350-700</p>	



Section 1: Electrodes

<p>CROWN P/N: 27380 NAME: SILENT GLOW OEM P/N: 36200 MODELS: UNKNOWN</p>	<p>CROWN P/N: 27493 NAME: SUNRAY OEM P/N: UNKNOWN MODELS: UNKNOWN</p>
<p>CROWN P/N: 27384 NAME: SILENT GLOW OEM P/N: UNKNOWN MODELS: UNKNOWN</p>	<p>CROWN P/N: 27498 NAME: SUNRAY OEM P/N: E40351 MODELS: HC, PHC, R, MR, PR / PMR 863 & 9833</p>
<p>CROWN P/N: 27386 NAME: SILENT GLOW OEM P/N: UNKNOWN MODELS: UNKNOWN</p>	<p>CROWN P/N: 27500 NAME: SUNRAY OEM P/N: E40393 MODELS: DC, GC, LC, GE, & PGC</p>
<p>CROWN P/N: 27388 NAME: SILENT GLOW OEM P/N: UNKNOWN MODELS: UNKNOWN</p>	<p>CROWN P/N: 27516 NAME: SUNRAY OEM P/N: E41211 MODELS: SHELL CONVERSION KIT</p>
<p>CROWN P/N: 27451 NAME: STEWART WARNER OEM P/N: 735062 MODELS: UNKNOWN</p>	<p>CROWN P/N: 27518 NAME: SUNRAY OEM P/N: UNKNOWN MODELS: UNKNOWN</p>
<p>CROWN P/N: 27452 NAME: STEWART WARNER OEM P/N: 6A-170054 MODELS: UNKNOWN</p>	<p>CROWN P/N: 27520 NAME: SUNRAY OEM P/N: UNKNOWN MODELS: UNKNOWN</p>
<p>CROWN P/N: 27480 NAME: SUNRAY OEM P/N: UNKNOWN MODELS: UNKNOWN</p>	<p>CROWN P/N: 27522 NAME: SUNRAY OEM P/N: EA46142-2 & 3 MODELS: OE-1 BURNER</p>
<p>CROWN P/N: 27490 NAME: SUNRAY OEM P/N: UNKNOWN MODELS: UNKNOWN</p>	<p>CROWN P/N: 27534 NAME: SUPERIOR BOILER OEM P/N: UNKNOWN MODELS: UNKNOWN</p>
<p>CROWN P/N: 27492 NAME: SUNRAY OEM P/N: E40491 MODELS: ICA, D2, D3 & G</p>	<p>CROWN P/N: 27536 NAME: SUPERIOR BOILER OEM P/N: UNKNOWN MODELS: UNKNOWN</p>

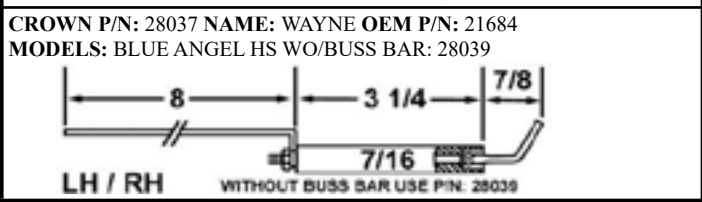
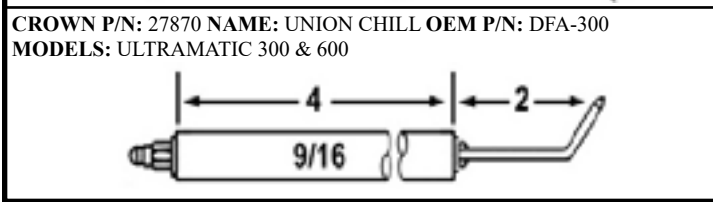
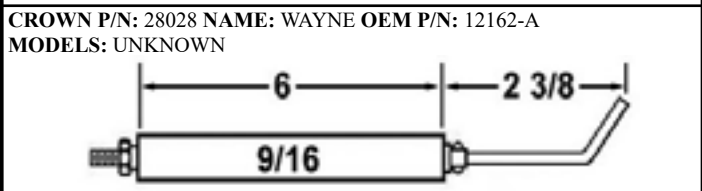
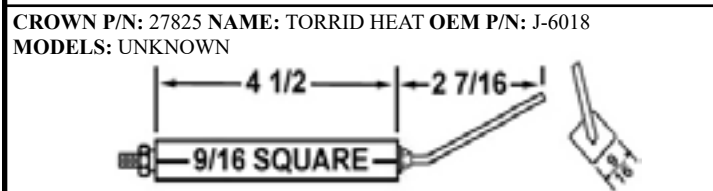
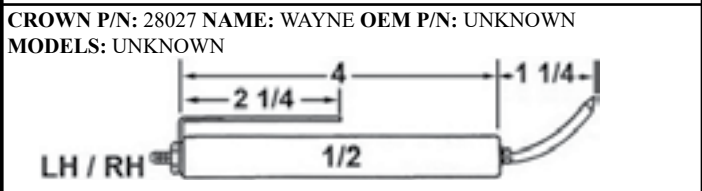
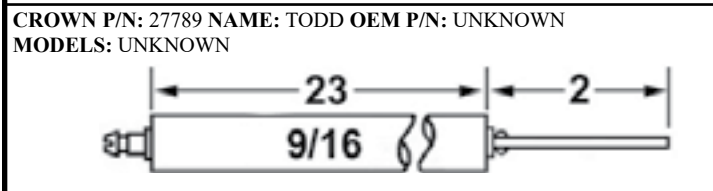
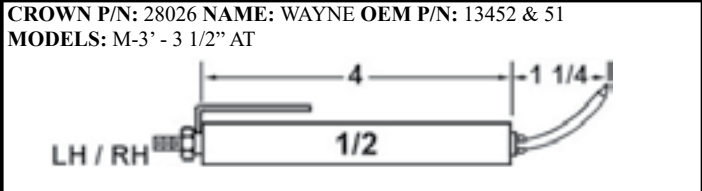
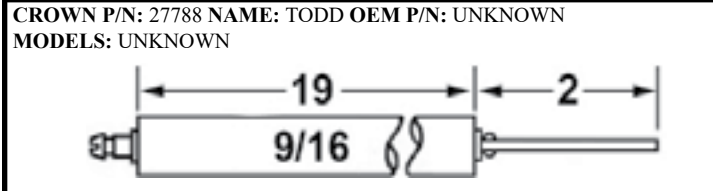
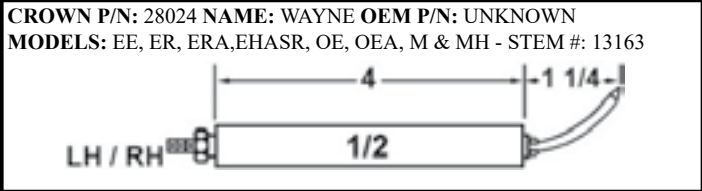
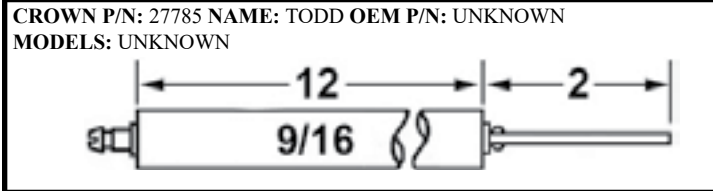
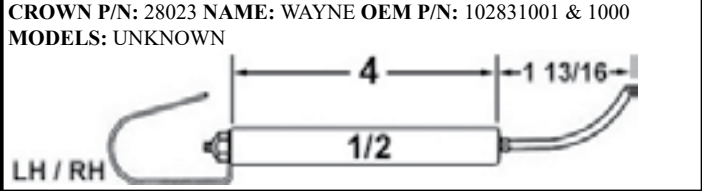
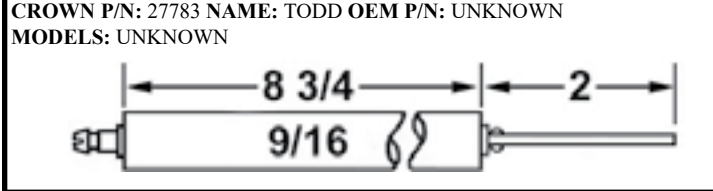
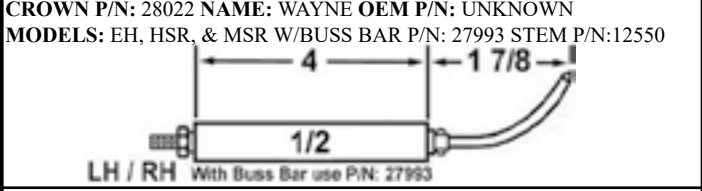
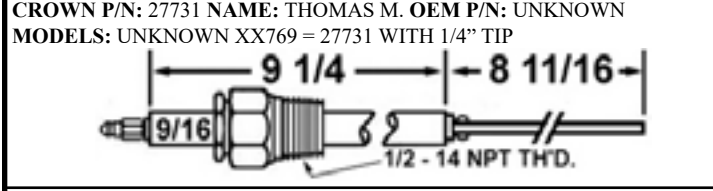
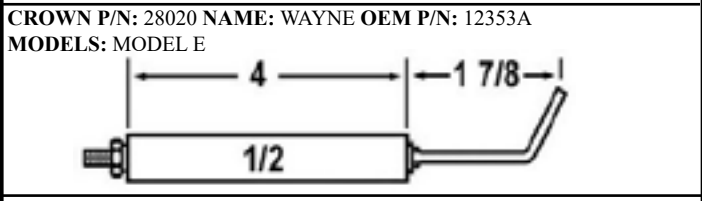
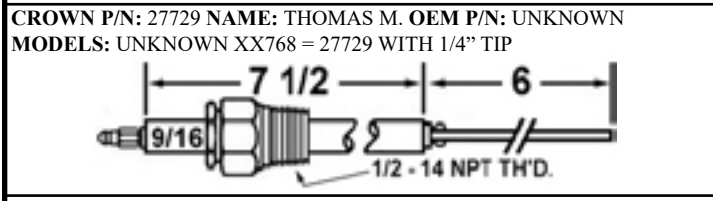
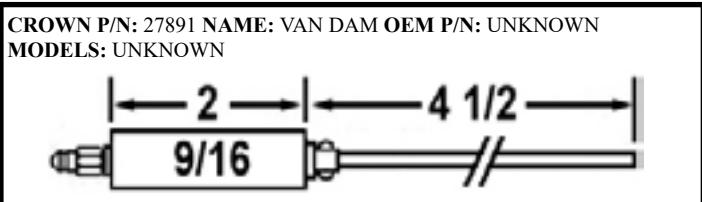
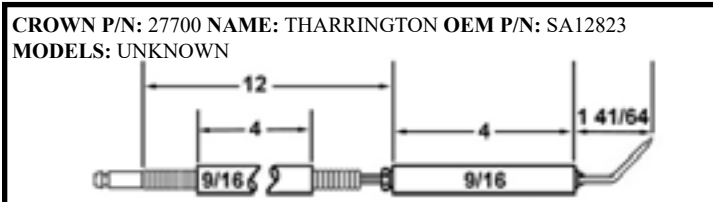



Section 1: Electrodes

CROWN P/N: 28038 **NAME:** WAYNE **OEM P/N:** 21684
MODELS: BLUE ANGEL HS - HEAVY TIP

CROWN P/N: 28039 **NAME:** WAYNE **OEM P/N:** 21684
MODELS: BLUE ANGEL HS WITHOUT BUSS BAR

CROWN P/N: 28040 **NAME:** WAYNE **OEM P/N:** 13934 & 13933
MODELS: EH PRESSURE WASHER

CROWN P/N: 28045
NAME: WAYNE
OEM P/N: 62390-002
MODELS: HSG SENSOR

CROWN P/N: 28046
NAME: WAYNE
OEM P/N: UNKNOWN
MODELS: UNKNOWN

CROWN P/N: 28047 **NAME:** WAYNE
OEM P/N: 62391-002
MODELS: HSG PROBE

CROWN P/N: 100989-061 **NAME:** WAYNE **OEM P/N:** UNKNOWN
MODELS: BLUE ANGEL HS ONE BLOCK STYLE. TRIM BB IN FIELD TO FIT AIR TUBE LENGTHS.

CROWN P/N: 28084 **NAME:** WEBSTER ENG. **OEM P/N:** 220029
MODELS: F / JB #1 & #2 BURNERS

CROWN P/N: 28091-01 **NAME:** WEIL-McLAIN
OEM P/N: 644-600-048 **MODELS:** QB180 & 300.
NOTE: WIRE LEADS SOLD SEPARATLY P/N: 70043-02.

CROWN P/N: 28302 **NAME:** YORK SHIPLEY **OEM P/N:** DBA-7303
MODELS: UNKNOWN

CROWN P/N: 28304 **NAME:** YORK SHIPLEY **OEM P/N:** UNKNOWN
MODELS: FOR DOMESTIC BURNERS

CROWN P/N: 28312 **NAME:** YORK SHIPLEY **OEM P/N:** 102841000
MODELS: FOR INDUSTRIAL BOILERS

CROWN P/N: 28314 **NAME:** YORK SHIPLEY **OEM P/N:** UNKNOWN
MODELS: UNKNOWN

CROWN P/N: 28316 **NAME:** YORK SHIPLEY **OEM P/N:** N-72074
MODELS: FOR INDUSTRIAL BOILERS

CROWN P/N: 28324 **NAME:** YORK SHIPLEY
OEM P/N: N-72970 **MODELS:** FOR INDUSTRIAL BOILERS

CROWN P/N: 28330 **NAME:** YORK SHIPLEY **OEM P/N:** 157313
MODELS: UNKNOWN

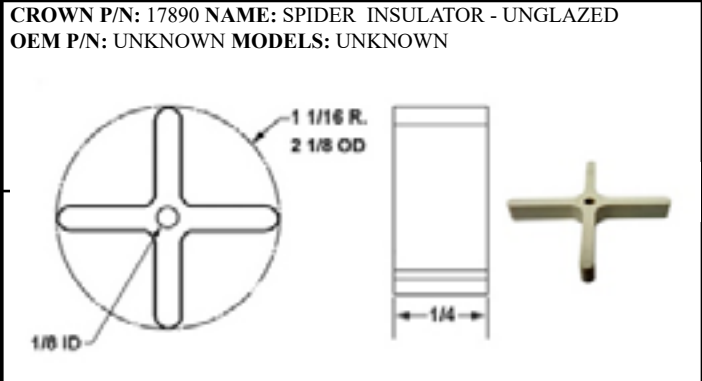
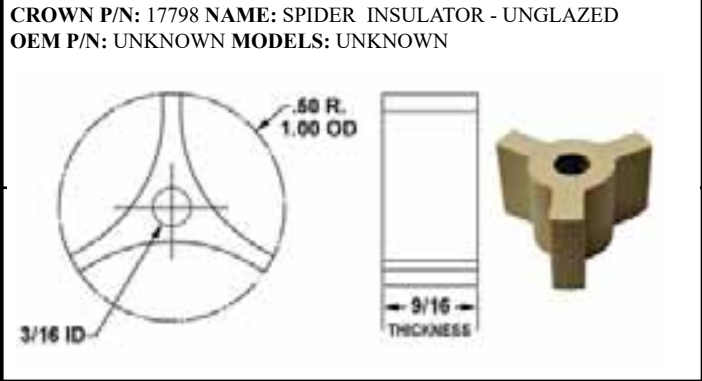
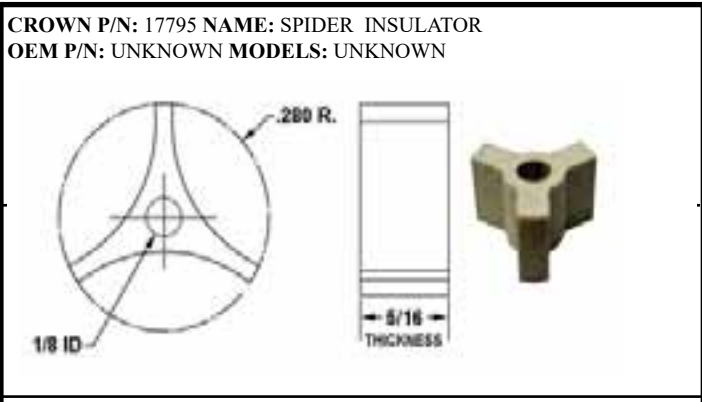
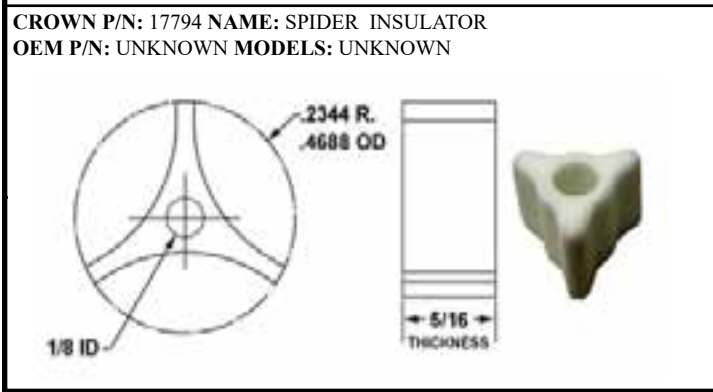
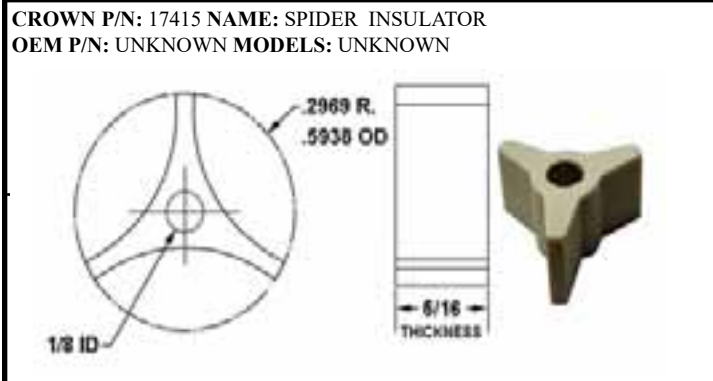
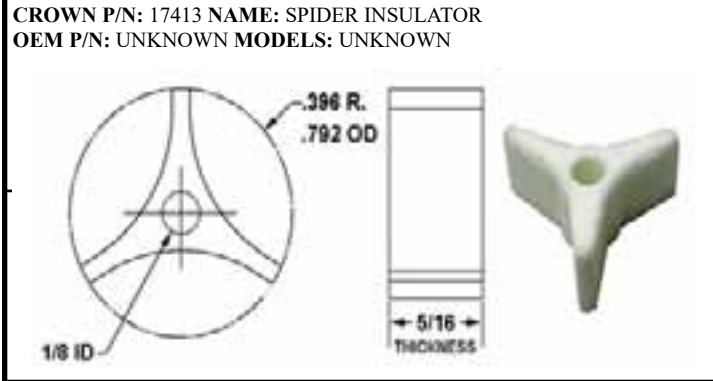
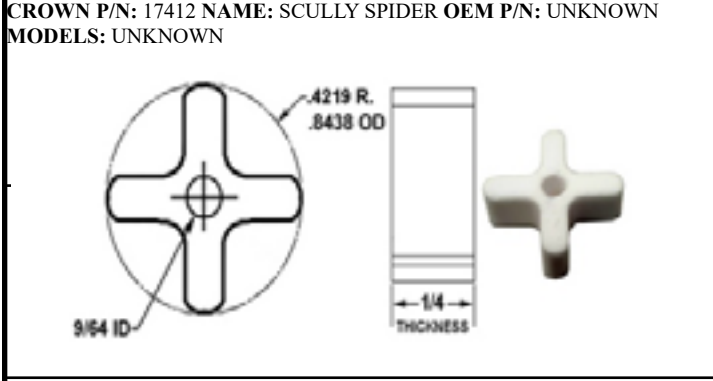
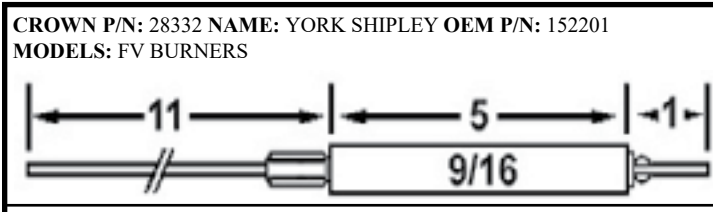

THIS SPACE LEFT BLANK INTENTIONALLY

THIS SPACE LEFT BLANK INTENTIONALLY



Section 1: Electrodes

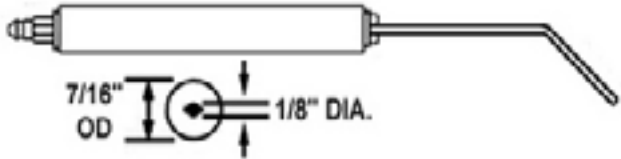

ELECTRODE PART NUMBER	INSULATOR ONLY P/N	LENGTH OF INSULATOR	TYPE OF TIP
01033	11033	3 3/4"	
01040	11040	4"	
01041	11041	4 1/4"	HEAVY
01042	11042	4 1/2"	1/8"
01043	11043	4 3/4"	DIA.
01050	11050	5"	
01060	11060	6"	

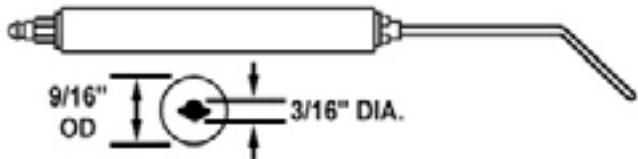

ELECTRODE PART NUMBER	INSULATOR ONLY P/N	LENGTH OF INSULATOR	TYPE OF TIP
05030	15030	3"	
05033	15033	3 3/4"	
05040	15040	4"	LIGHT
05042	15042	4 1/2"	3/32"
05050	15050	5"	DIA.
05052	15052	5 1/2"	
05060	15060	6"	
05070	15070	7"	

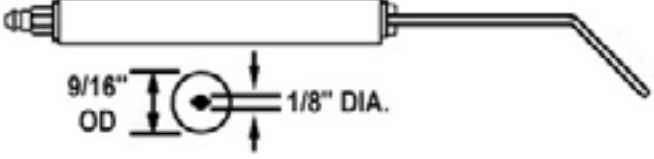

ELECTRODE PART NUMBER	INSULATOR ONLY P/N	LENGTH OF INSULATOR	TYPE OF TIP
02040	12040	4"	
02041	12041	4 1/4"	
02042	12042	4 1/2"	
02050	12050	5"	HEAVY
02052	12052	5 1/2"	1/8"
02060	12060	6"	DIA.
02070	12070	7"	
02080	12080	8"	
02090	12090	9"	

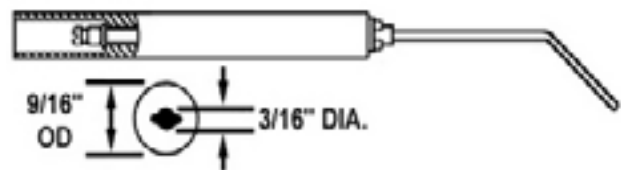

ELECTRODE PART NUMBER	INSULATOR ONLY P/N	LENGTH OF INSULATOR	TYPE OF TIP
06040	16040	4"	
06042	16042	4 1/2"	LIGHT
06050	16050	5"	3/32"
06060	16060	6"	DIA.
06070	16070	7"	



ELECTRODE PART NUMBER	INSULATOR ONLY P/N	LENGTH OF INSULATOR	TYPE OF TIP
03040	13040	4"	HEAVY
03050	13050	5"	1/8"
03060	13060	6"	DIA.

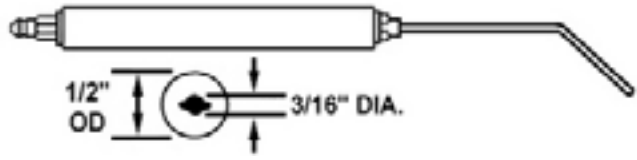

ELECTRODE PART NUMBER	INSULATOR ONLY P/N	LENGTH OF INSULATOR	TYPE OF TIP
09040	19040	4"	
09042	19042	4 1/2"	LIGHT
09050	19050	5"	3/32"
09060	19060	6"	DIA.
09070	19070	7"	
09080	19080	8"	

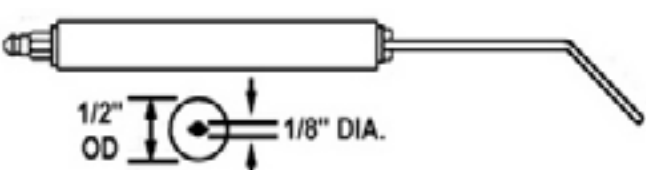

ELECTRODE PART NUMBER	INSULATOR ONLY P/N	LENGTH OF INSULATOR	TYPE OF TIP
04040	14040	4"	
04042	14042	4 1/2"	HEAVY
04050	14050	5"	1/8"
04052	14052	5 1/2"	DIA.
04060	14060	6"	

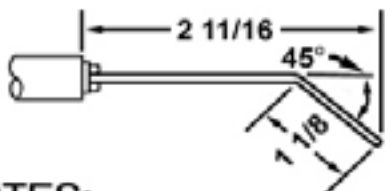

NOTES:
 Longer insulator lengths available upon request. Tips can be supplied straight and in standard length of 3". Longer lengths can be supplied upon request. Add the letter S, after the electrode part number, when ordering the straight electrode.
 Insulators packaged 2, 10 or 25 to a box. Add a — (dash) and the number 2, 10 or 25 to insulator P/N when ordering insulators.



Decimal Conversion Chart

Inch	Decimal Inch	Millimeters	Inch	Decimal Inch	Millimeters
1/64	0.015625	0.396785	33/64	0.515625	13.096875
1/32	0.03125	0.79375	17/32	0.53125	13.49375
3/64	0.046875	1.190625	35/64	0.546875	13.890625
1/16	0.0625	1.5875	9/16	0.5625	14.2875
5/64	0.078125	1.984375	37/64	0.578125	14.684375
3/32	0.09375	2.38125	19/32	0.59375	15.08125
7/64	0.109375	2.778125	39/64	0.609375	15.478125
1/8	0.125	3.175	5/8	0.625	15.875
9/64	0.140625	3.571875	41/64	0.640625	16.271875
5/32	0.15625	3.96875	21/32	0.65625	16.66875
11/64	0.171875	4.365625	43/64	0.671875	17.065625
3/16	0.1875	4.7625	11/16	0.6875	17.4625
13/64	0.203125	5.159375	45/64	0.703125	17.859375
7/32	0.21875	5.55625	23/32	0.71875	18.25625
15/64	0.234375	5.953125	47/64	0.734375	18.653125
1/4	0.25	6.35001	3/4	0.75	19.05
17/64	0.265625	6.746875	49/64	0.765625	19.446875
9/32	0.28125	7.14375	25/32	0.78125	19.84375
19/64	0.296875	7.540625	51/64	0.796875	20.240625
5/16	0.3125	7.9375	13/16	0.8125	20.6375
21/64	0.328125	8.334375	53/64	0.828125	21.034375
11/32	0.34375	8.73125	27/32	0.84375	21.43125
23/64	0.359375	9.128125	55/64	0.859375	21.828125
3/8	0.375	9.525	7/8	0.875	22.225
25/64	0.390625	9.921875	57/64	0.890625	22.621875
13/32	0.40625	10.31875	29/32	0.90625	23.01875
27/64	0.421875	10.715625	59/64	0.921875	23.415625
7/16	0.4375	11.1125	15/16	0.9375	23.8125
29/64	0.453125	11.509375	61/64	0.953125	24.209375
15/32	0.46875	11.90625	31/32	0.96875	24.60625
31/64	0.484375	12.303125	63/64	0.984375	25.003125
1/2	0.50	12.7	1	1.0	25.4



Part Number: 100950K
 Wayne Blue Angel + tune up kit-6" air tube
Packaging: Poly bag hang card

- Includes**
- 1 - Electrode assembly (100989-013)
 - 1 - Setting gauge (14200-002)
 - 1 - Oil line 3/16" X 8" L (14452)
 - 1 - Coupler w/end caps (100386)
 - 1 - Elbow (13494)
 - 1 - Buss bar support (13276)

For use on Blue Angel Plus burner model HS up to 6" air tube.



Part Number: 28091K
 Weil-McLain tune up kit QB180/300
Packaging: Poly bag hang card

- Includes**
- 1 - 28091-01 Electrode assembly (644-600-048)
 - 2 - 70043 Wire ignition leads (644-000-043)
 - 1 - Oil line - straight 3/16" X 11" (40362B)
 - 1 - KK500WM Coupler with end caps (644-700-186)
 - 1 - Instruction sheet

For use on burner models QB-180 & 300



Part Number: 100989K
 Wayne Blue Angel + tune up kit-over 6" air tube
Packaging: Poly bagged & Tagged

- Includes**
- 1 - Electrode assembly (100989-061)
 - 1 - Setting gauge (14200-002)
 - 1 - Oil line 3/16" X 8" L (14452)
 - 1 - Coupler w/end caps (100386)
 - 1 - Elbow (13494)
 - 1 - Buss bar support (13276)

For use on Blue Angel Plus burner model HS over 6" air tubes.



Part Number: 31156K
 Wayne tune up kit - E & M Series
Packaging: Poly bag hang card

- Includes**
- 2 - Electrode assemblies (13286)
 - 2 - Electrode Stems (12550)
 - 2 - Buss bars 8" (10004-015)
 - 2 - Insulator bushings (12408)
 - 1 - Oil line 3/16" X 8" L (14452)
 - 1 - Coupler w/end caps (13279)
 - 1 - Setting gauge (14200)
 - 1 - Elbow (13494)
 - 1 - Buss bar support (13276)
 - 1 - Instruction sheet

For use on burner models M, MSR, MH, ERA, EH, EHA, EHASR, OE, & OEA.



Part Number: 31157K
 Wayne tune up kit - Old HS
Packaging: Poly bag hang card

- Includes**
- 1 - Electrode w/buss bar (21666-013)
 - 1 - Electrode w/buss bar (21667-013)
 - 1 - Setting gauge (14200-002)
 - 1 - Oil line 3/16" X 8" L (14452)
 - 1 - Coupler w/end caps (100386)
 - 1 - Elbow (13494)
 - 1 - Buss bar support (13276)
 - 1 - Instruction sheet

For use on OLD Blue Angel burner model HS

NOTE: This kit excludes the electrode bracket holder Wayne P/N: 21679, which is usually reused when servicing. If you would like a kit that includes the electrode holder please order our P/N: **31157KH**



Part Number: 21705U
 Beckett Igniton Leads Set
Packaging: Poly bagged

- Includes**
- 1 - Set of ignition leads
- For use on burner models AF II
 1/4" quick connect transformer wires.



Section 2 - Tune-up Kits & Service Parts



Part Number: 40261
 Adams/Beckett electrode kit
Packaging: Poly bag with label
Includes
 1 - 20070 Electrode assembly
 1 - 20417 Flame rod assembly
 For use on G2 gas burners.

Part Number: 40263
 Powerflame electrode kit
Packaging: Poly bag with label
Includes
 1 - 26887 Electrode assembly
 1 - 26894 Flame rod assembly
 Used on Columbia boilers.

Adams Manufacturing Electrode Set P/N: 40261
 Used in Beckett models G2 gas burners.

Power Flame Electrode Set P/N: 40263
 Used in burner models C, J, & CG

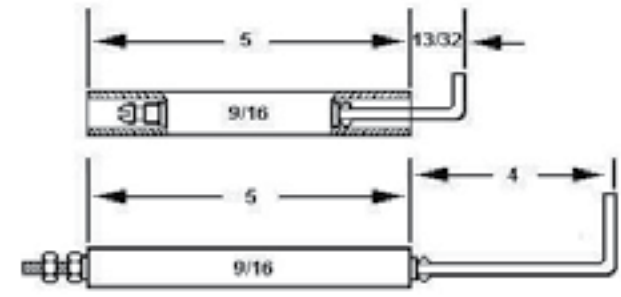
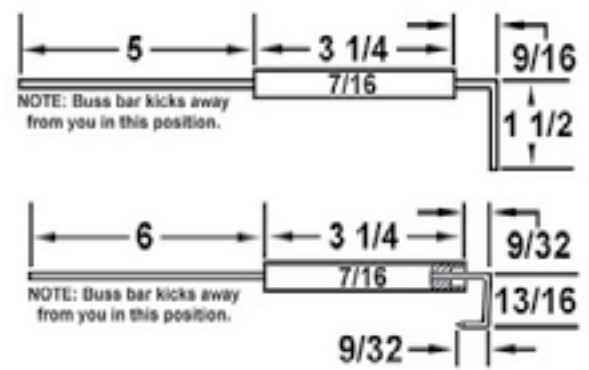

Part Number: 40262
 Patterson-Kelley electrode kit
Packaging: Poly bag with label
Includes
 1 - 26796 Electrode assembly
 1 - 26798 Flame rod assembly
 For use on burner models
 N-700 thru N-2000

Part Number: 40264
 Wayne electrode kit HSG200/400
Packaging: Poly bag with label
Includes
 1 - 28045 Flame rod assembly
 1 - 28047 Electrode assembly
 For use on burner models HSG200 & 400

Patterson-Kelley Electrode Set P/N: 40262
 Used in burner models N-700 thru N-2000

Wayne Electrode Set P/N: 40264
 Used in burner models HSG200 & HSG400

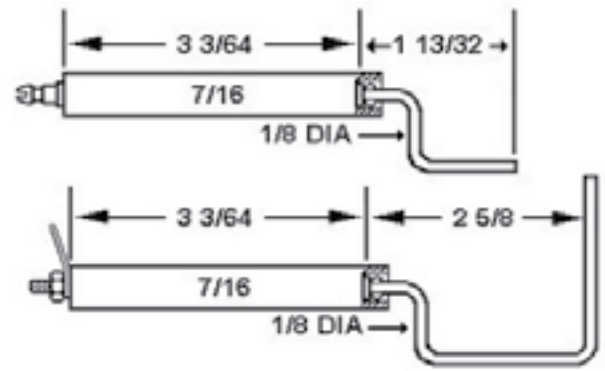
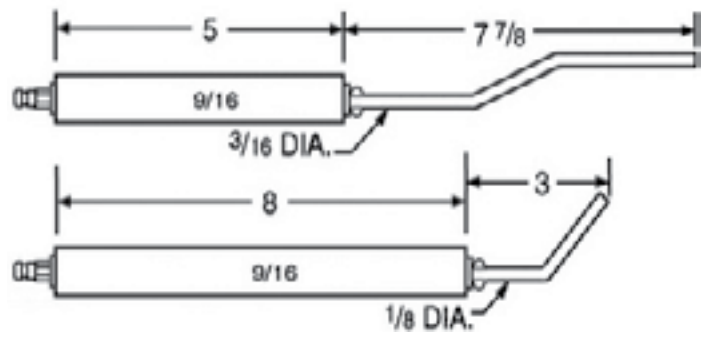



Part Number: 40275

Electrode ignition Kit - "PRO" kit

Packaging: Durable plastic carrying case

Includes

This kit contains a variety of ignition terminals, standard electrodes, popular OEM electrodes, and other necessary accessories to get burners up and running. Don't leave the shop without it!



Terminals and Hardware

Quantity	Contents
10 ea.	50000 Cage terminal
10 ea.	50100 Spring terminal
10 ea.	50200 Ring terminal
10 ea.	50450 Right angle cage terminal
10 ea.	50600 Stud ferrule
10 ea.	50760 Hex base stud 6-32 thread.
10 ea.	50700 Hex base stud 10-32 thread.
5 ea.	50860 Hollow stud 6-32 thread.
5 ea.	50800 Hollow stud 10-32 thread.
10 ea.	50900 Eyelet
10 ea.	60018 Flat hex nut 6-32 thread.
10 ea.	60022 Flat hex nut 10-32 thread.

Special OEM Electrodes

Quantity	Contents
2 ea.	20410 Beckett
2 ea.	20780 Carlin
2 ea.	28022 Wayne

Special Tools

Quantity	Contents
1 ea.	40430 Igniter tip bending set
1 ea.	40445 Electrode setting gauge

Buss Bars

Quantity	Contents
2 ea.	40315 Round buss bar - 12" long
2 ea.	40320 Flat buss bar - 12" long

Standard Electrodes

Quantity	Contents
4 ea.	01041
2 ea.	03050
2 ea.	04040
4 ea.	05040
4 ea.	05050
2 ea.	05060
2 ea.	06040
2 ea.	06042
2 ea.	06050
2 ea.	06060

Test Jumpers, Cable, and Chart

Quantity	Contents
1 ea.	40630 Set of booted test leads
1 ea.	5 ft. length GTO-15 ignition cable
1 ea.	Trouble shooting chart

Section 2 - Tune-up Kits & Service Parts



Part Number: 40277
 Electrode roll-up kit "MECHANIC"
Packaging: Durable plastic roll-up pouch

Includes
 This kit includes 8 different standard electrodes, and 2 - O.E.M. electrode assemblies designs. It also contains 10 of the most universal insulators in the oil heat industry to restore service due to electrode or insulator failure.
 Contains the following parts:

<u>Standard electrodes</u>	<u>Insulators</u>
2 ea. 05040	2 ea. 11041
2 ea. 05050	2 ea. 15040
2 ea. 05060	2 ea. 15050
2 ea. 06050	2 ea. 15060
	2 ea. 16050

O.E.M. electrode
 2 ea. 20411 Beckett
 2 ea. 20418B 6" buss bar



Part Number: 40279
 Electrode kit "SERVICEMAN'S"
Packaging: Durable plastic case

Includes
 This kit includes 16 different standard electrodes, and 4 - O.E.M. electrode assemblies and 20 of the most popular insulators in the industry.
 Contains the following parts:

<u>Standard electrodes</u>	<u>Insulators</u>
4 ea. 05040	4 ea. 11041
4 ea. 05050	4 ea. 15040
4 ea. 05060	4 ea. 15050
4 ea. 06050	4 ea. 15060
	4 ea. 16050

O.E.M. Electrodes
 4 ea. 20411 Beckett
 4 ea. 20418B 6" buss bar



Part Number: 40278
 Electrode kit "MASTER"
Packaging: Durable plastic roll-up pouch
Includes: This kit includes 20 different standard electrodes to provide a variety that will help any master mechanic to restore service due to electrode failure.
 Contains the following parts:

<u>Standard electrodes</u>	<u>Standard electrodes</u>
2 ea. 01041	2 ea. 04040 w/hex nut
2 ea. 01060	2 ea. 04040
2 ea. 02040	2 ea. 05040
2 ea. 02050	2 ea. 05050
2 ea. 02060	2 ea. 05060



Part Number: 40282
 Carlin electrode kit
Packaging: Durable plastic roll-up pouch
Includes
 This kit includes 22 of the most popular Carlin replacement electrodes in the field today. These O.E.M. replacements make a perfect match every time!
 Contains the following parts:

O.E.M. electrode(s)

2 ea. 20710	2 ea. 20725	2 ea. 20765
2 ea. 20720	2 ea. 20730	2 ea. 20770
2 ea. 20715	2 ea. 20760	6 ea. 20780





Part Number: 40283
 Beckett electrode roll-up kit

Packaging: Durable plastic roll-up pouch

Includes

This kit includes 18 of the most popular R. W. Beckett replacement electrodes. A perfect match every time!
 Contains the following parts:

O.E.M. electrode(s)

- | | | | |
|-------------|-------------|-------------|-------------|
| 4 ea. 20410 | 2 ea. 20413 | 2 ea. 20437 | 2 ea. 20415 |
| 2 ea. 20411 | 2 ea. 20414 | 2 ea. 20441 | 2 ea. 20420 |



Part Number: 40290
 Electrode repair kit - "Build an electrode"

Packaging: Durable plastic carrying case

Includes

This kit contains a variety of replacement insulators, rods and accessories to custom make your own electrode's for emergency and long term standard upgrades. A must for any, "NO HEAT", service call.

Qty. Contents

- 6 ea. 11041 Glazed insulator - 7/16" dia. x 4 1/4" long
- 6 ea. 15050 Glazed insulator - 9/16" dia. x 5" long
- 6 ea. 16050 Glazed insulator - 9/16" dia. x 5" long w/CB
- 3 ea. Package of assorted fasteners, nuts, and washers
- 2 ea. 40305 Electrode rod pack - 10-32 thread.
- 1 ea. 40300 Electrode rod pack - 6-32 thread.
- 1 ea. 40400 Terminal crimping tool / electrode rod cutter



Part Number: 40284
 Wayne electrode roll-up kit

Packaging: Durable plastic roll-up pouch

Includes

This kit includes 18 of the most popular Wayne burner replacement electrodes. A perfect match every time!
 Contains the following parts:

O.E.M. electrode(s)

- | | | | |
|-------------|-------------|-------------|-----------|
| 2 ea. 28020 | 2 ea. 28023 | 2 ea. 28026 | 2 ea. 280 |
| 4 ea. 28022 | 4 ea. 28024 | 2 ea. 28028 | |



Part Number: 51345C
 Beckett electrode kit CF 800/500

Packaging: Poly bag

Includes:

- 2 - Electrode assemblies
 - 1 - Instruction sheet
- For use on burner models CF 800 and CF 500 up to 8" air tube combinations.



Part Number: 40286K

Carlin electrode tune up kit

Packaging: Poly bag hang card

Includes:

- 2 - 20762 Electrode assemblies
 - 1 - Yellow electrode setting gauge
 - 1 - Red electrode setting gauge
 - 1 - Instruction sheet
 - 1 - KK100 coupler w/end caps
 - 1 - 12" L x 3/16" Dia. copper oil line
- For use on burner models 98 - 102, elite, 201 CRD & 301 CRD.



Part Number: 51346C

Beckett electrode kit CF 800/500 Over 8" AT

Packaging: Poly bag

Includes

- 2 - Electrode assemblies
 - 1 - Instruction sheet
- For use on burner models CF 800 and CF 500 over 8" air tube combinations.





Part Number: 51484U
 Beckett electrode kit AFII-85/150
Packaging: Poly bagged & tagged

Includes:
 2 - Electrode assemblies
 2 - Transformer wires
 1 - Multi-purpose setting gauge
 1 - Instruction sheet
 For use on burner models AFII-85 and AFII-150 with air tube combination models HLX - HB, HC, HD, and HE up to 9" air tube combinations.



Part Number: 51811U
 Beckett electrode kit model NX
Packaging: Poly bagged & tagged

Includes:
 2 - Electrode assemblies
 2 - Couplings
 2 - Rod extension - 4 7/8" L
 2 - Rod extension - 2 7/8" L
 1 - Instruction sheet
 For use on burner model NX.
 (Setting gauge sold separately, order P/N: 40439)



Part Number: 51670U
 Beckett electrode kit AFII
Packaging: Poly bagged & tagged

Includes:
 2 - Electrode assemblies
 2 - lead wires with assorted connectors
 1 - Extension hdwr., Instruction Sheet & gauge
 For use on burner models AFII 85 & 150 burners EA16711L for FBX burner head up to 9"



Part Number: 51859
 Beckett electrode kit model CF375
Packaging: Poly bagged & tagged

Includes:
 2 - Electrode assemblies
 2 - Support insulators
 1 - Instruction sheet
 For use on burner model CF375.

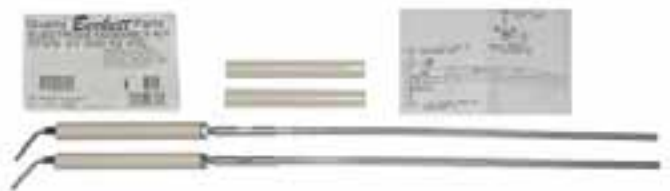

Part Number: 51771U
 Beckett solid state ignitor A,AF & AFG
Packaging: Boxed & tagged

Includes:
 1 each Igniter With Base Plate Used in models A, AF, AFG and NX Burners. 120VAC/60HZ/35VA/6kv RMS output voltage.



Part Number: 5780C
 Beckett electrode kit AFG, AF, AR,SF, SR
Packaging: Poly bagged & tagged

Includes:
 2 - Electrode assemblies
 2 - Connector studs
 2 - Extension rods
 2 - 10/32 Hex nuts
 1 - Instruction sheet
 For use on burner models AFG, AF, AR, SF, & SR burners up to 9" air tube combinations.
 (Setting gauge sold separately, order P/N: 40443)



Part Number: 51212C
 Beckett electrode kit for CF1400 / CF3500
Packaging: Poly bagged & tagged

Includes:
 2 - Electrode assemblies
 For use on Beckett burner models CF1400 & CF3500





Part Number: 5780K
Beckett electrode tune up kit AF, AR, SF, & SR

- Packaging:** Poly bag hang card
Includes:
2 - Electrode assemblies w/connectors
2 - Extension rods
2 - 10/32 Hex nuts
1 - Instruction sheet
1 - KK100 coupler w/end caps
1 - 12" L x 3/16" Dia. copper oil line
1 - 40443 Electrode setting gauge
For use on burner models AF, AR, SF, & SR burners up to 9" air tube combinations.

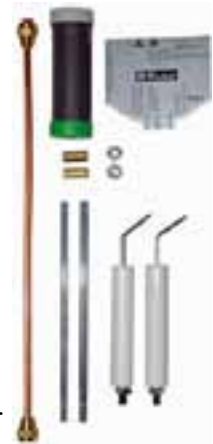

Part Number: 5782K
Beckett electrode tune up kit AF, AR, SF, & SR 9"+ AT

- Packaging:** Poly bag hang card
Includes:
2 - Electrode assemblies w/connectors
2 - Secondary support insulators
2 - Extension rods
2 - 10/32 Hex nuts
1 - Instruction sheet
1 - KK100 coupler w/end caps
1 - 12" L x 3/16" Dia. copper oil line
1 - 40443 Electrode setting gauge
For use on burner models AF, AR, SF, & SR burners over 9" air tube combinations.

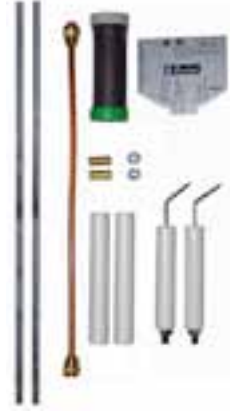

Part Number: 5781C
Beckett electrode kit model A & S

- Packaging:** Heat sealed poly bag
Includes:
2 - Electrode assemblies
2 - Connector studs
2 - Spring connectors
2 - Extension rods
2 - 10/32 Hex nuts
1 - Instruction sheet
For use on burner models A & S burners up to 9" air tube combinations.



Part Number: 5783
Beckett electrode kit model A & S 9"+ AT

- Packaging:** Heat sealed poly bag
Includes:
2 - Electrode assemblies
2 - Support insulators
2 - Bullet connector studs
2 - Extension rods
2 - 10/32 Hex nuts
1 - Instruction sheet
For use on burner models A & S burners over 9" air tube combinations.



Part Number: 5782C
Beckett electrode tune up kit AFG, AF, AR, SF, & SR

- Packaging:** Poly bagged & tagged
Includes:
2 - Electrode assemblies
2 - Support insulators
2 - Connector studs
2 - Extension rods
2 - 10/32 Hex nuts
1 - Instruction sheet
For use on burner models AFG, AF, AR, SF, & SR burners over 9" air tube combinations.
(Setting gauge sold separately, order P/N: 40443)



Part Number: 578705
Beckett electrode set EA22406C

- Packaging:** Poly bagged & tagged
Includes:
2 - Electrode assemblies
1 - Instruction sheet
For use on a variety of private label burner models AF & SF. Reference #EA22406C





Part Number: 578707C
 Beckett electrode kit AFG, AF, SF, AF-90
Packaging: Heat sealed poly bag
Includes:
 2 - 20418 Electrode assemblies (EA28406C)
 For use on a variety of private name brand burner models. Used in models AFG, AF, SF, AF-90 series burners up to 9" air tubes.



Part Number: 578716
 Beckett electrode kit AFG & SF
Packaging: Poly bagged & tagged
Includes:
 2 - Electrode assemblies
 For use on a variety of private label burner models AFG & SF. Reference #EA23906K.



Part Number: 578708C
 Beckett electrode kit AFG & SF
Packaging: Poly bagged & tagged
Includes:
 2 - Electrode assemblies
 For use on burner models AFG & SF with 7 1/4" long air tubes. Reference #EA24106C



Part Number: 578723C
 Beckett electrode kit AF, SF & SM
Packaging: Heat sealed poly bag
Includes:
 2 - 20401 Electrode assemblies (EA15802B) used on a variety of private name brand burner models. Used in models AF, AF-44 series, SF, and SM burners. 4 1/2" air tube only.



Part Number: 578711C
 Beckett electrode kit AF-10/15
Packaging: Poly bagged & tagged
Includes:
 2 - Electrode assemblies
 For use on burner models AF-10 & AF-15. Reference #EA13302B.



Part Number: 5940
 Beckett electrode kit MB, & MD
Packaging: Poly bag & tagged
Includes:
 2 - Electrode assemblies
 2 - Female connector studs
 2 - Extension rods
 For use on burner models MB & MD burners up to 9" air tube combinations. use on burner models CF 800 and CF 500 up to 8" air tube combinations.

Part Number: 578712C
 Beckett electrode kit AFG & SF
Packaging: Poly bagged & tagged
Includes:
 2 - Electrode assemblies used on a variety of private name brand burner models for AFG & SF. Reference # EA21506C.



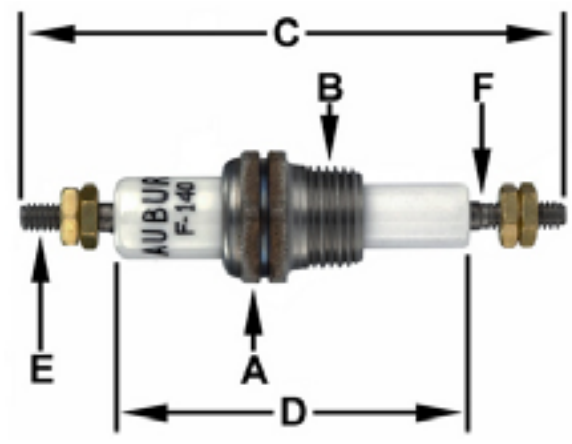

Electric Feed-throughs

Auburn electric feed-throughs are used in oil and gas filled transformers and switching equipment.

Additional applications include terminals and overloads in hermetic air conditioning and refrigeration compressors, explosion proof electric motors, generators, autoclaves, and centrifugal and submersible pumps.

They are compact and their one piece design assures positive electrical and leak-proof connection into the pressure vessel.

AUBURN ELECTRIC FEED- THROUGH ELECTRODES										
P/N	A	B	C	D	E	F	CONDUCTOR MATERIAL	CURRENT RATING	FLASH OVER	MAX. OPER TEMP
F-140	13/16" S/S	3/8" - 18	3.57	2.33	10 - 24	3/16" DIA	KOVAR	30 AMPS	8 KV	600° F
F-150	13/16" S/S	5/8" - 24	3.57	2.33	10 - 24	3/16" DIA	KOVAR	30 AMPS	8 KV	600° F
F-200-1H	13/16" CAD	3/8" - 18	4.45	2.71	1/4" - 20	1/4" DIA	BRASS	105 AMPS	8 KV	200° F
F-210-1H	13/16" CAD	3/8" - 18	4.45	2.71	1/4" - 20	1/4" DIA	COPPER	175 AMPS	8 KV	200° F
F-230-1H	13/16" CAD	5/8" - 18	4.45	2.71	1/4" - 20	1/4" DIA	COPPER	175 AMPS	8 KV	200° F
F-220-1B	13/16" CAD	5/8" - 18	4.20	2.71	1/4" - 20	1/4" DIA	BRASS	105 AMPS	8 KV	200° F
F-240LLH	7/8" CAD	1/2" - 14	5.17	3.67	1/4" - 20	1/4" DIA	BRASS	105 AMPS	14 KV	200° F
F-250LLH	7/8" CAD	1/2" - 14	5.17	3.67	1/4" - 20	1/4" DIA	COPPER	175 AMPS	14 KV	200° F
F-310-H	1 1/8" CAD	3/4" - 14	5.23	3.23	3/8" - 16	3/8" DIA	COPPER	275 AMPS	12 KV	200° F
F-610	1 3/8" CAD	1" 11 1/2	5.91	3.17	5/8" - 11	5/8" DIA	COPPER	750 AMPS	8 KV	200° F
F-630	1 3/8" CAD	1" 11 1/2	7.68	3.67	5/8" - 11	5/8" DIA	COPPER	750 AMPS	10 KV	200° F
F-670	1 3/8" CAD	1" 11 1/2	6.92	3.67	5/8" - 11	5/8" DIA	COPPER	750 AMPS	10 KV	200° F
F-690	1 3/8" CAD	1" 11 1/2	8.29	3.17	5/8" - 11	5/8" DIA	COPPER	750 AMPS	8 KV	200° F

Champion Spark Plugs

Crown Part Number	Thread Size	Crown Part Number	Thread Size
25	14 MM	K97F	18 MM
CJ8	14 MM	*K98F	OBSOLETE
D23	18 MM	RJ12YC	14 MM
D89D	18 MM	RL87YC	14 MM
D9	18 MM	RN13LYC	14MM
ED-89D	18 MM	UD16	18 MM
F-121500	14 MM	UY6	10 MM
F-121501	14 MM	W18	7/8" - 18
F-121502	14 MM	W89D	7/8" - 18
F-121503	14 MM	W95D	7/8" - 18
F-121507	14 MM	Z6	10 MM
H-14-Y	14 MM	Z9Y	10 MM
J99	14 MM	NOTE: K97F REPLACES K98F	



SPECS FOR EACH PLUG ON PAGES TO FOLLOW

Section 3 - Industrial Igniters & Flame Rods

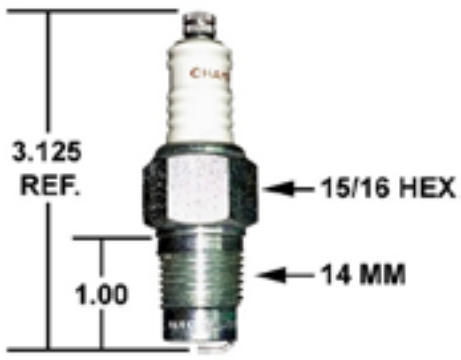

25

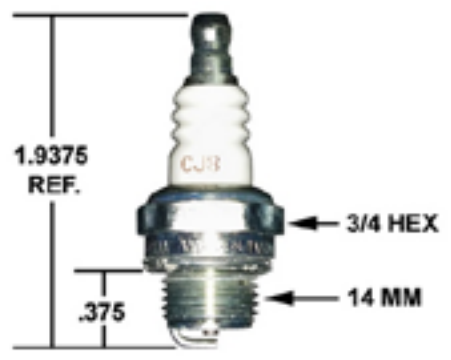

CJ8



D23



D89D



D9



ED-89D



F-121500
(aka FI-21500)



F-121501
(aka FI-21501)



F-121502
(aka FI-21502)

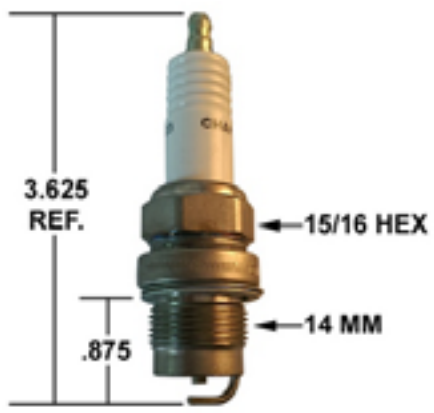

F-121503
 (aka FI-21503)



F-121507
 (aka FI-21507)



H-14-Y



J99



K97F



RJ12YC



RL87YC



RN13LYC



UD16



UY6



W18



W89D



W95D



Z6



Z9Y

SPECIAL NOTE

There are a number of Auburn / Champion items that are not shown in this catalog edition because of a lack of sales history or perhaps deemed obsolete by the manufacturer.

If you have a reference number you don't see, please call us to see if is still available.



149T



F-68

NOTE: Crown generic available: CA250



PART NUMBER	"A" DIM.
FRS-2 SERIES	
1/2" NPT MOUNTING THD.	
P/N	"A" - DIM
FRS-2-6	6"
FRS-2-12	12"
FRS-2-18	18"
FRS-2-24	24"

NOTE: Crown generic available: CA390 thru CA393



FRS-3 SERIES

NOTE: Crown generic available: CA410



FRS-4 SERIES	
1/4" NPT MOUNTING THD.	
P/N	"A" - DIM
FRS-4-4	4"
FRS-4-6	6"
FRS-4-12	12"
FRS-4-18	18"
FRS-4-24	24"

FRS-4 SERIES

NOTE: Crown generic available: CA430 thru CA441

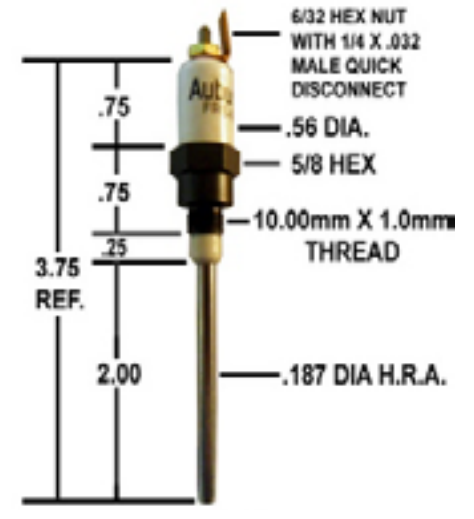

FRS-9

Section 3 - Industrial Igniters & Flame Rods



I-10-25



I-101

NOTE: Crown generic available: CA500



I-102

NOTE: Crown generic available: CA502



I-143

NOTE: Crown generic available: CA503



I-144

NOTE: Crown generic available: CA645



I-18

NOTE: Crown generic available: CA200



I-18-14

NOTE: Crown generic available: CA210



I-18-18



I-18-24

NOTE: Crown generic available: CA203



I-181



I-182 SERIES			
PART NUMBER	"A" DIM	"B" DIM	"C" DIM
I-182	3.43	1.12	.06
I-182-1	3.53	1.25	.19



I-18K

NOTE: Crown generic available: CA240



PART NUMBER	"A" DIM.	"B" DIM.
I-2	8.00	4.50
I-2-1	15.50	12.00
I-2-2	27.50	24.00

I-2 SERIES		
PART NUMBER	"A" DIM	"B" DIM
I-2	8.00	4.50
I-2-1	15.50	12.00
I-2-2	27.50	24.00

I-2 SERIES
 NOTE: Crown generic available:
 CA100 thru CA102

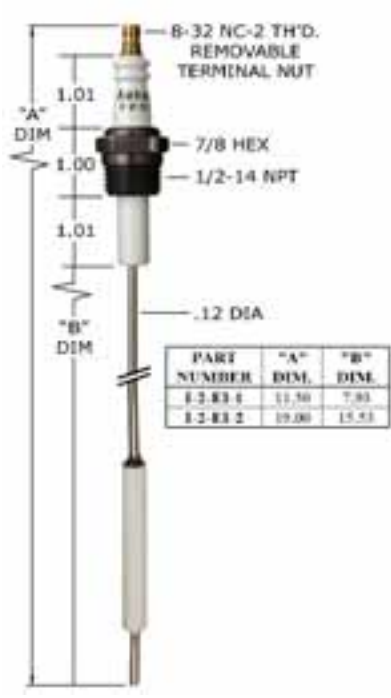

I-2-EI SERIES		
PART NUMBER	"A" DIM	"B" DIM
I-2-EI-1	11.50	7.94
I-2-EI-2	19.00	15.53

I-2-EI-1 & I-2-EI-2
 NOTE: Crown generic available:
 CA107 & CA108



I-25

NOTE: Crown generic available: CA230



I-28



I-3

NOTE: Crown generic available: CA470



I-31

NOTE: Crown generic available: CA505



I-31-1 & I-31-3

NOTE: Crown generic available for I-31-1: CA506



I-31-2

NOTE: Crown generic available: CA507



I-31-5

NOTE: Crown generic available: CA510



I-31-6

I-32 NO LONGER AVAILABLE
 USE PART NUMBER CA515



I-33

NOTE: Crown generic available: CA490



I-5-99

NOTE: Crown generic available: CA370



I-6

NOTE: Crown generic available: CA140 thru CA146



P/N	"A" DIM	"B" DIM
I-64-1	4.20	1.72
I-64-3	6.24	3.75
I-64-4	3.60	1.12

NOTE: Crown generics available



P/N	"A" DIM	"B" DIM
I-75-1	4.31	.81
I-75-6	3.81	.28
I-75-5*	4.21	.71

***NOTE:** DOES NOT HAVE A SIDE WIRE.



I-78-2



I-82



IA-9

NOTE: Crown generic available: CA180

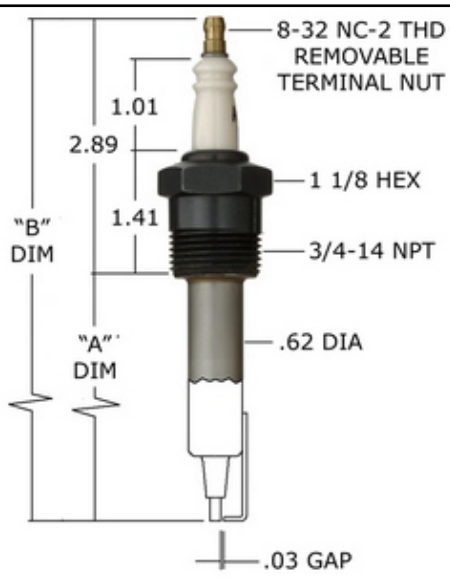

**I-90 SERIES
 Shrouded Igniters**

I-90 SERIES		
PART NUMBER	"A" DIM	"B" DIM
I-90-3	9.00	11.89
I-90-6	12.125	15.0125
I-90-7	10.00	12.89
I-90-8	15.75	18.64



IC-9-2

NOTE: Crown generic available: CA480

Section 3 - Industrial Igniters & Flame Rods



IC-9-5

NOTE: Crown generic available: CA482

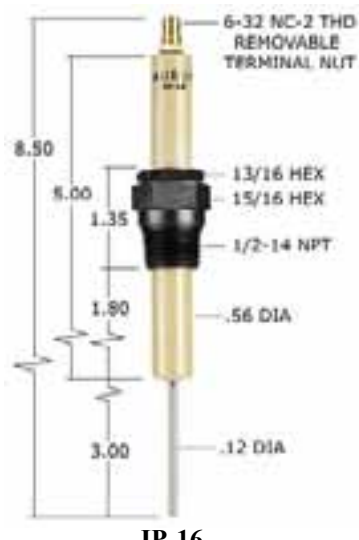

IP-16

NOTE: Crown generic available: CA290

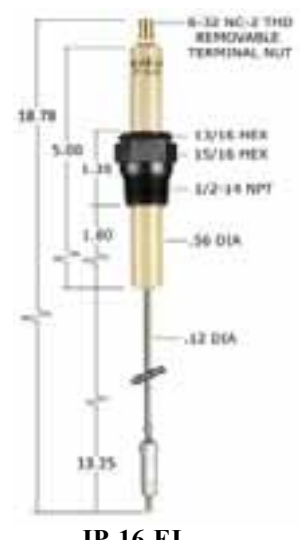

IP-16-EI

NOTE: Crown generic available: CA304



IP-17

NOTE: Crown generic available: CA310



OJ-21-4

NOTE: Crown generic available: CA488



SI-140



SI-180



SI-185



SI-186

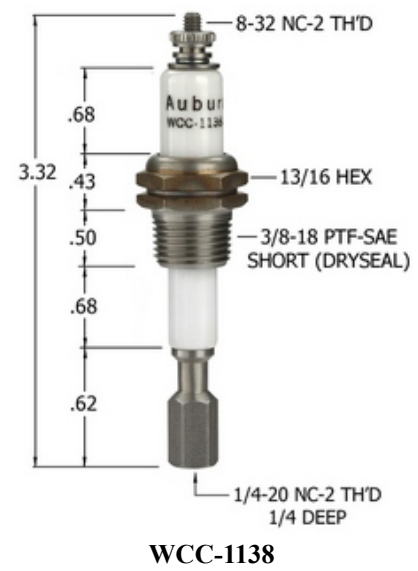

NOTE: Replaces WCC-1138KH



Section 3 - Industrial Igniters & Flame Rods

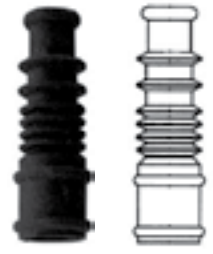

PROTECTOR BOOT		
USED ON	CATALOG NO.	MATERIAL
Flame Rods	022046	Black Silicone

SPECIFICATIONS:
 Overall length: 2 3/8"
 Top ID: 1/4"
 Bottom ID: 1/2"
 Temp Rating: 300 Degrees Fahrenheit

022046

“SI” Series Protector Boot



50741

90 Degree Silicone Boot - Black
 450° F Max. temperature rating
 For use with 7mm wire

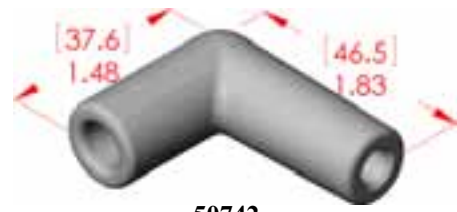

50742

90 Degree Silicone Boot - Grey
 450° F Max. temperature rating
 For use with 7mm wire

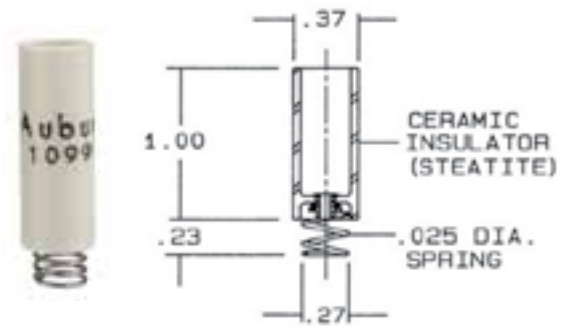

1099-C

Ceramic terminal connector - Auburn

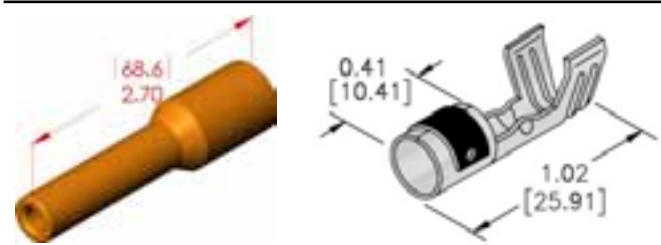

50743

Straight Silicone Boot - orange with terminal
 450° F Max. temperature rating for use with 7mm wire.
 Use crimping tool 40407 or 40408

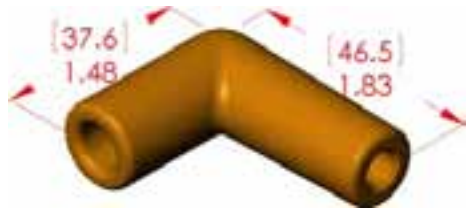

50739

90 Degree Silicone Boot - Orange
 450° F Max. temperature rating
 For use with 7mm wire

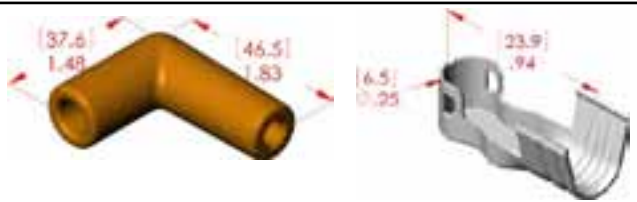

50744

90 Degree Silicone Boot - orange - with terminal
 450° F Max. temperature rating for use with 7mm wire.
 Use crimping tool 40407 or 40408



50740

Straight Silicone Boot
 450° F Max. temperature rating
 For use with 7mm wire



50745

Straight Ceramic Boot with terminal 2 3/8 L. Fits 9/16 dia. Ins.
 1000° F Max. temperature rating for use with 7mm wire.
 Use crimping tool 40407 or 40408



50746

90 Degree Ceramic Boot with terminal
 1000° F Max. temperature rating for use with 7mm wire
 Use crimping tool 40407 or 40408

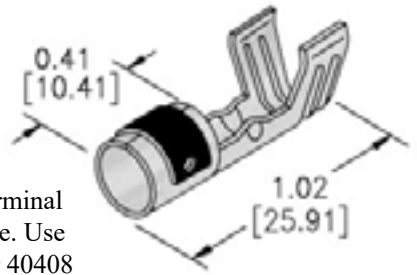

61900

Straight spark plug terminal
 For use with 7mm wire. Use crimping tool 40407 or 40408

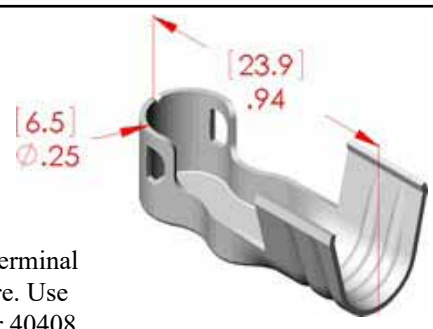

61901

90 Degree spark plug terminal
 For use with 7mm wire. Use crimping tool 40407 or 40408

Part Number(s):

- P-380-L (3/4" HEX x 3/8" NPT TH'D. - 500 psi)
 - P-500-L (27/32" HEX x 1/2" NPT TH'D. - 500 psi)
 - P-750-L (1 1/16" HEX x 3/4" NPT TH'D. - 500 psi)
 - P-1000-L (1 3/8" HEX x 1" NPT TH'D. - 500 psi)
 - P-1140-L (1 3/4" HEX x 1 1/4" NPT TH'D. - 500 psi)
 - P-1122-L (2" HEX x 1 1/2" NPT TH'D. - 500 psi)
- Observation Ports - Lenz Brand

Packaging: Poly bagged & tagged

Includes: 1 - observation port from the above list.

Quality one piece construction. Cold rolled steel with electroless nickel plate. Bora Silica lens is heated and molded into shell body for superior sealing. Ports have Buna seals and are compatible with petroleum based fluids, gasoline, lube oil fuel and a variety of solvents.

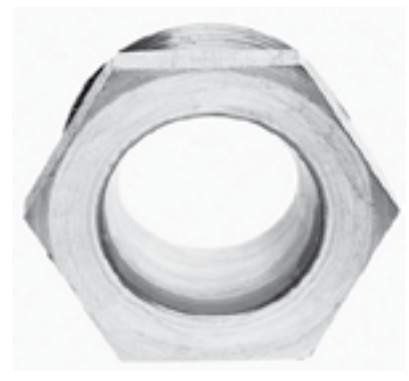

Part Number(s):

- P-380 (3/4" hex with a 3/8"-18 thread - MOP 350 psi)
 - P-500 (7/8" hex with a 1/2"-14 thread - MOP 275 psi)
 - P-750 (1 1/8" hex with a 3/4"-14 thread - MOP 200 psi)
 - P-1000 (1 3/8" hex with a 1" - 11 1/2" thread - MOP 150 psi)
- Observation Ports - Auburn

Packaging: Poly bagged & tagged

Includes: 1 - observation port from the above list.

Unsurpassed quality! Our ports offer unitized cico-weld construction with no organic gasket. Our one piece design is compact and leakproof at high temperatures and pressures. Maximum operating temperature is 400 degrees Fahrenheit. Maximum operating pressure (MOP) range from 150 thru 350 psi as specified above.

Prodes - Stainless Steel & Brass

Made of quality brass and stainless steel all our probes have a standard length of 24" with a threaded end.

Our probes give you the reach you need and can be cut to size in the field if it's too long.

Crown P/N	Probe DIA	Probe THD.	Material
40001B	3/16"	10-24	BRASS
40002B	1/4"	1/4-20	BRASS
40003B	3/8"	3/8-16	BRASS
40001S	3/16"	10-24	STAINLESS
40002S	1/4"	1/4-20	STAINLESS
40003S	3/8"	3/8-16	STAINLESS





CA Series Industrial Igniters & Flame Rods

Crown Engineering Corporation, the original OEM manufacturer of electrodes, igniters, and flame rods for oil and gas burners, is proud to announce it's new line of industrial igniters and flame rods.

Never before has Crown's quality and workmanship been so evident, as in our NEW industrial line of igniters and flame rods. You can select from a wide variety of stocked items in this catalog or we can B.T.O. (build to order) against your submitted samples and/or drawings...your choice!

Our industrial igniters and flame rods match the original OEM critical specs from the seat of the gland nut to the tip of the center wire or from the end of the gland nut thread to the tip of the center wire, whichever is applicable. Our protruding insulator length or over-all length proves to be of no significance in the field application. All of our igniters are made of high quality heat resistant alloy (H.R.A.) center wires and grade L3 Steatite glazed insulators (except wherever noted). In high pressure applications center wires are cemented in place and Viton® O-rings are included inside the gland nut assemblies. We look forward to serving all your industrial application needs.

Flame Rod Note: Flame rods are for low voltage applications and are not to be used as spark igniters. They should not be used with transformers, the porcelain will fail.



P/N	"A" DIM	"B" DIM	REPLACES
CA100	8.00	4.50	I-2
CA101	15.50	12.00	I-2-1
CA102	27.50	24.00	I-2-2
CA103	39.50	36.00	I-2-36
CA104	51.50	48.00	I-2-48
CA105	21.50	18.00	I-2-18
CA106	41.56	38.00	I-2-38
CA109	54.56	51.00	I-2-51
CA110	12.56	9.00	I-2-9
CA111	33.56	30.00	I-2-30
CA112	55.56	52.00	I-2-52

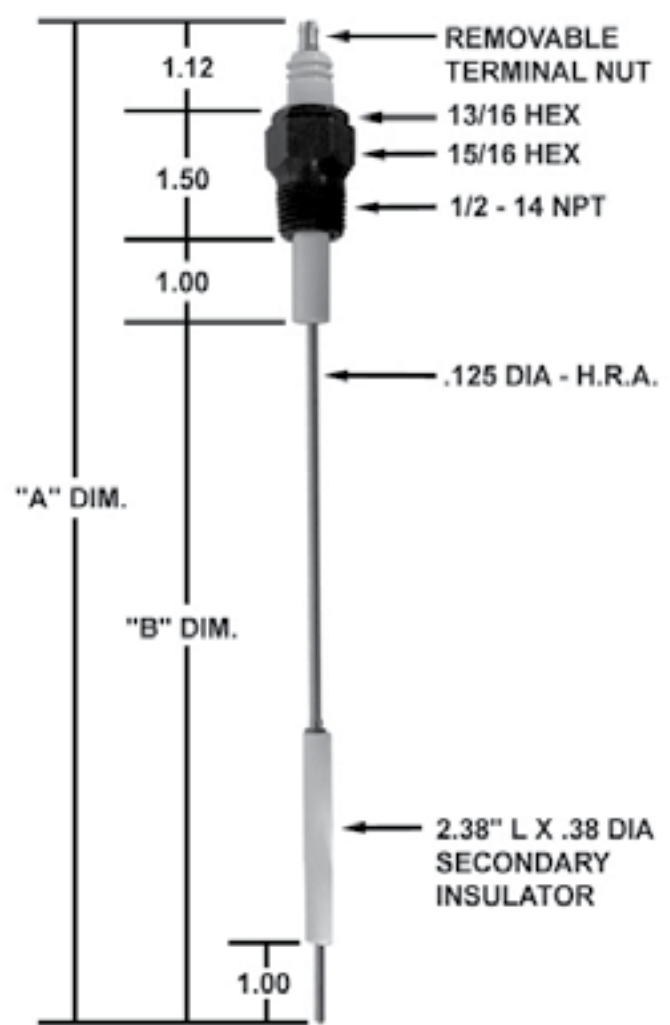

P/N	"A" DIM	"B" DIM	REPLACES
CA107	11.62	8.00	I-2-EI-1
CA108	19.37	15.75	I-2-EI-2

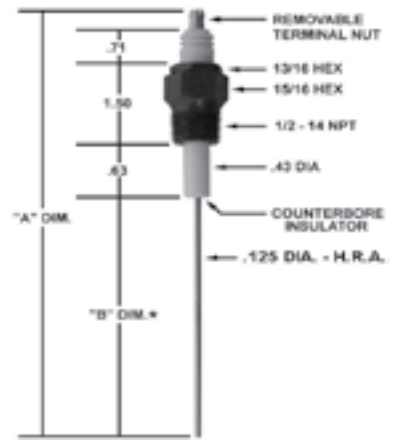
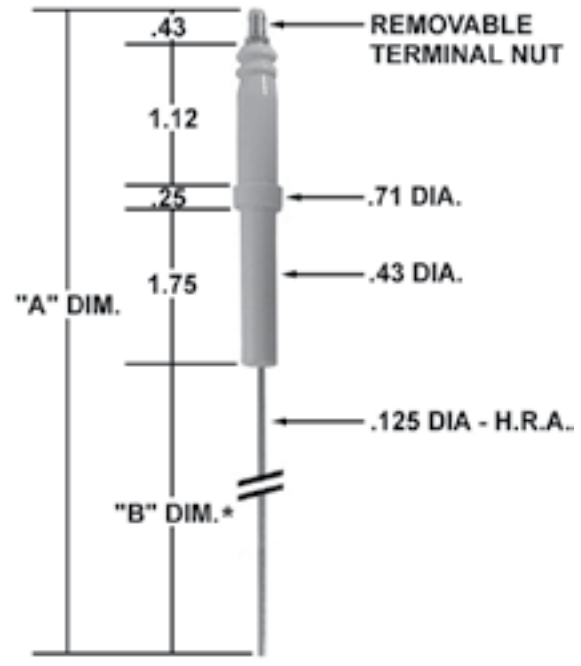

P/N	"A" DIM	"B" DIM	REPLACES
CA120	8.05	4.50	I-2 INS
CA121	15.55	12.00	I-2-1 INS
CA122	21.55	18.00	I-2-2 INS

P/N	"A" DIM	"B" DIM	REPLACES
CA140	8.14	4.90	I-6
CA141	9.24	6.00	I-6-6
CA142	15.24	12.00	I-6-12
CA143	21.24	18.00	I-6-18
CA144	27.24	24.00	I-6-24
CA145	38.24	35.00	I-6-35
CA146	51.24	48.00	I-6-48
CA149	7.43	4.50	ECL 16946-2
CA154	3.99	.75	I-6 SPEC

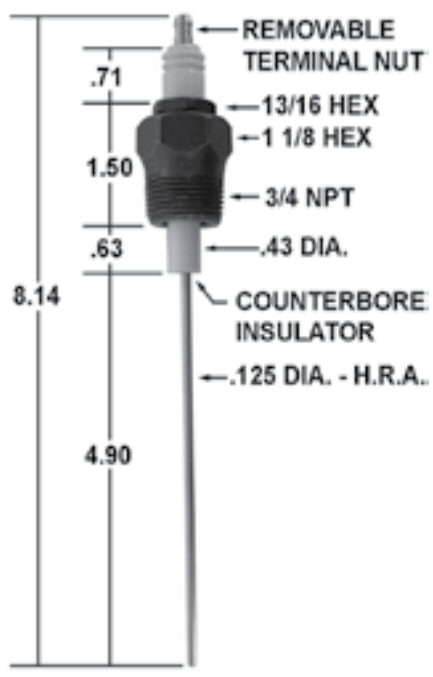

CA155
Industrial Igniter - Special
 * NOTE: Other tip lengths are available

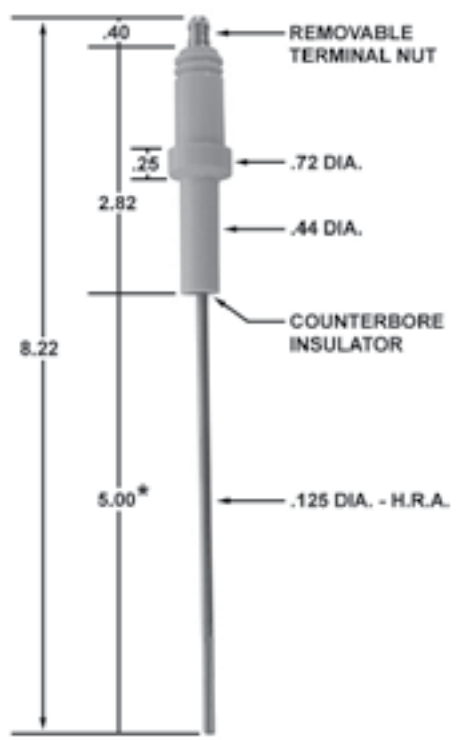

CA160
Replaces Auburn #: I-6 INS
 * NOTE: Other tip lengths are available

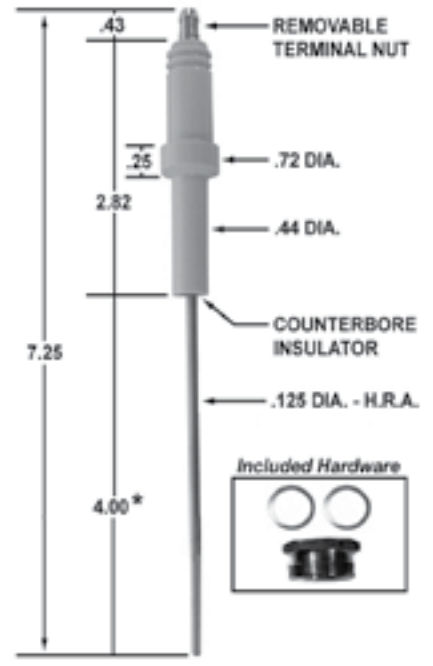

CA180
Replaces Auburn #: IA-9
 * NOTE: Other tip lengths are available

Section 3 - Industrial Igniters & Flame Rods



P/N	"A" DIM	"B" DIM	REPLACES
CA190	7.34	4.03	IP-9
CA191	16.31	13.00	IP-9-13
CA192	9.31	6.00	IP-9-6
CA195	27.31	24.00	IP-9-24

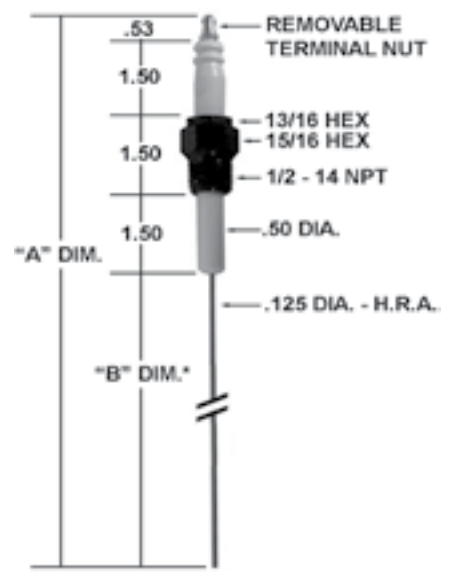

P/N	"A" DIM	"B" DIM	REPLACES
CA200	12.53	7.50	I-18
CA201	5.91	.88	I-18-2.38
CA202	23.03	18.00	I-18-18
CA203	29.03	24.00	I-18-24
CA203-1	30.03	25.00	I-18-25
CA204	41.03	36.00	I-18-36
CA205	53.03	48.00	I-18-48
CA206	55.03	50.00	I-18-50
CA206	77.03	72.00	I-18-72

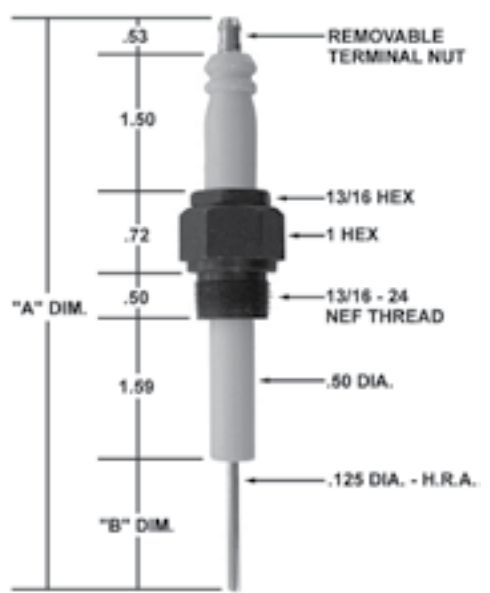

P/N	"A" DIM	"B" DIM	REPLACES
CA210	6.27	1.43	I-18-14
CA211	7.84	3.00	I-18-14-3

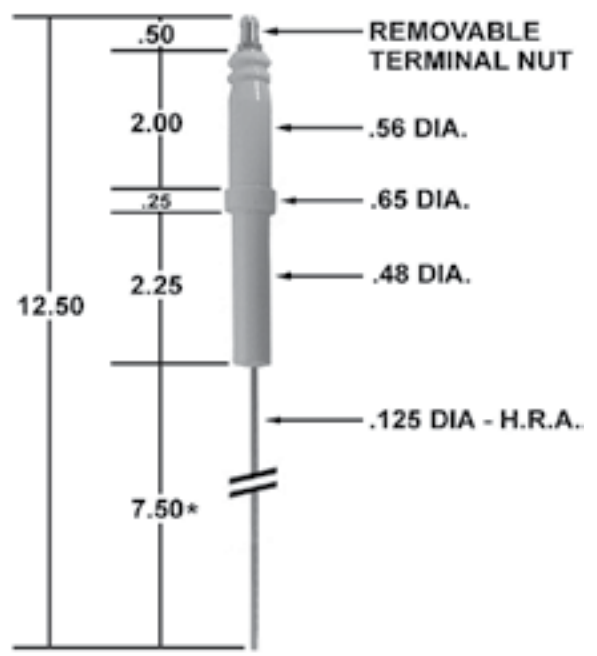

CA220

* NOTE: Other tip lengths are available

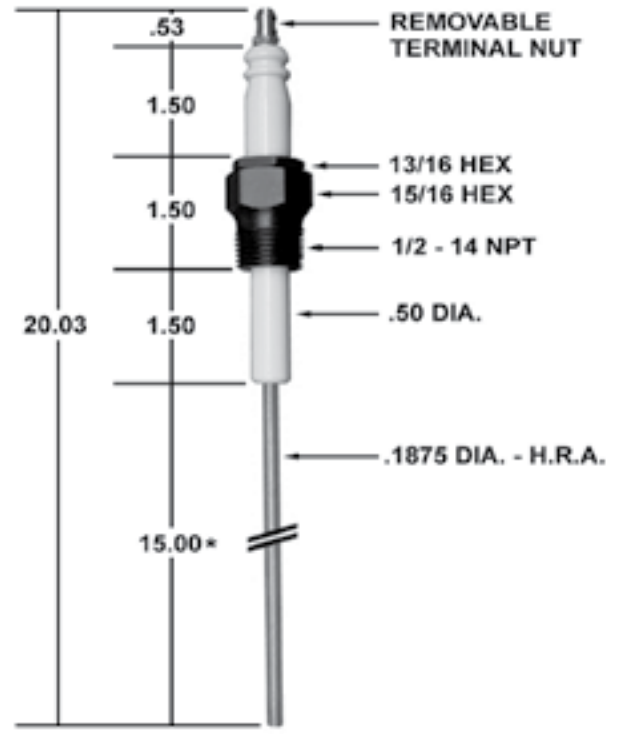

CA240
 Replaces Auburn #: I-18K
 * NOTE: Other tip lengths are available

P/N	"A" DIM	"B" DIM	"C" DIM	REPLACES
CA230	4.32	1.72	.09	I-25
CA231	6.35	3.75	.09	I-25-3
CA231U	6.19	3.75	.09	I-25-5
CA232	6.73	3.13	.12	12568
CA233	7.15	4.55	.12	17396
CA235	7.72	5.12	.06	17652

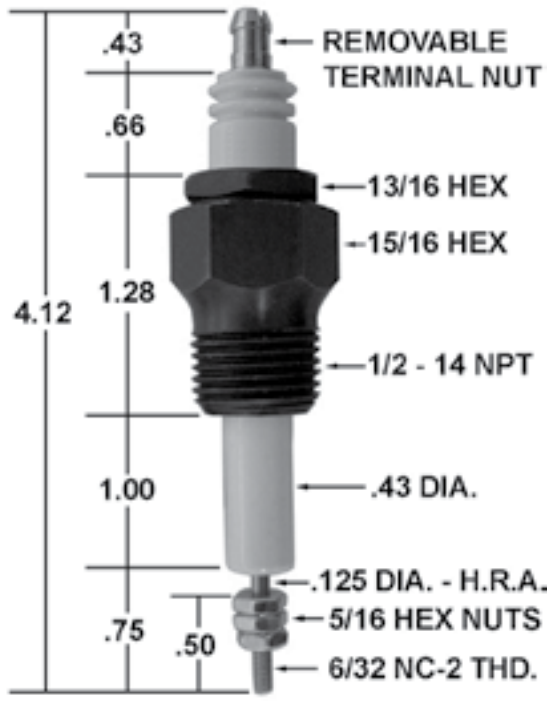

CA250
 Replaces Auburn #: F-68

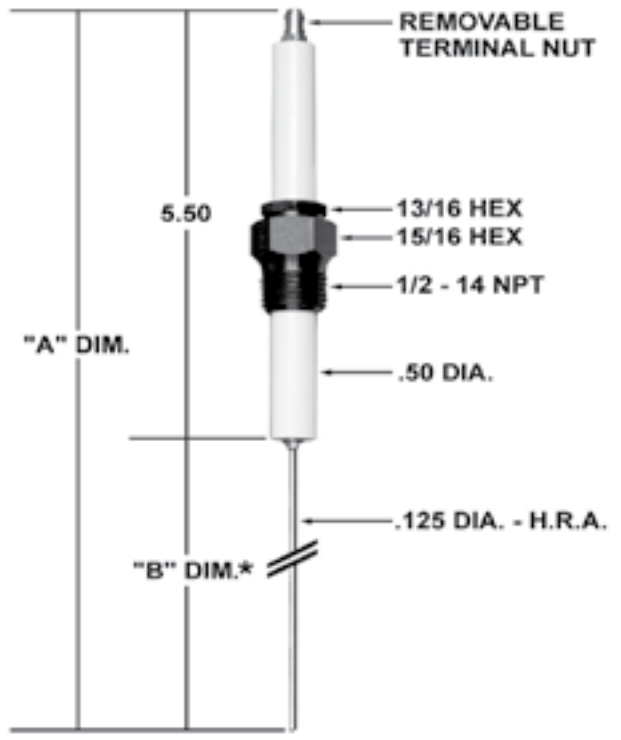

P/N	"A" DIM	"B" DIM	REPLACES
CA260	12.03	6.00	IP-15
CA262	22.03	16.00	IP-15-16

Section 3 - Industrial Igniters & Flame Rods



P/N	"A" DIM	"B" DIM	REPLACES
CA270	12.03	6.00	IA-15
CA280	11.21	5.21	IA-15-1

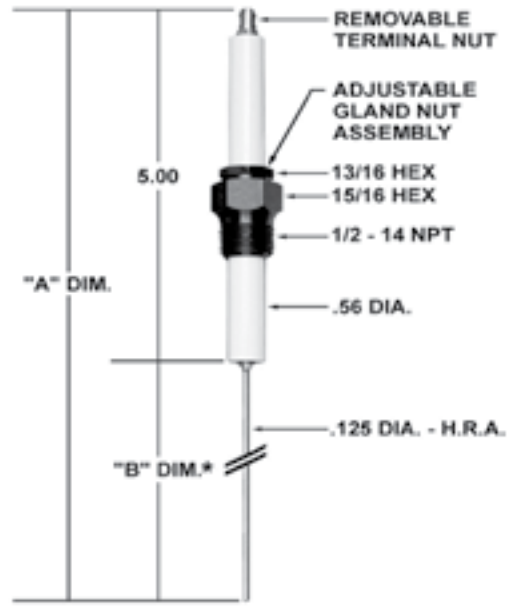

P/N	"A" DIM	"B" DIM	REPLACES
CA290	8.50	3.00	IP-16
CA291	11.50	6.00	IP-16-6
CA293	29.50	24.00	IP-16-24
CA294	35.50	30.00	IP-16-30
CA303	18.50	13.00	IP-16-13

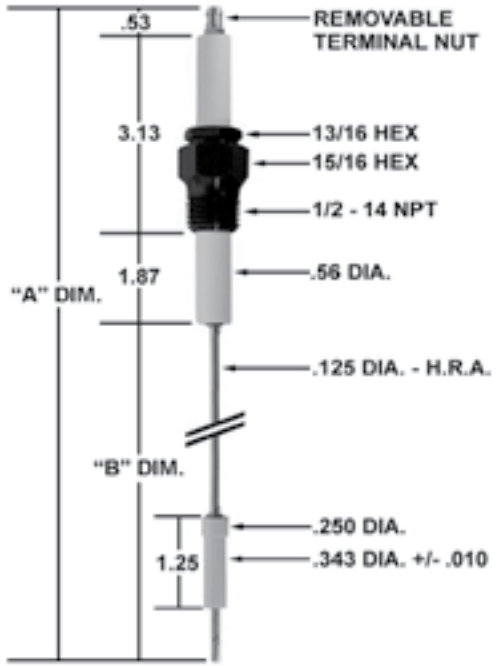

P/N	"A" DIM	"B" DIM	REPLACES
CA304	18.78	13.25	IP-16-EI
CA305	11.75	6.25	IP-16-EI-1
CA306	24.00	18.47	IP-16-EI SPEC

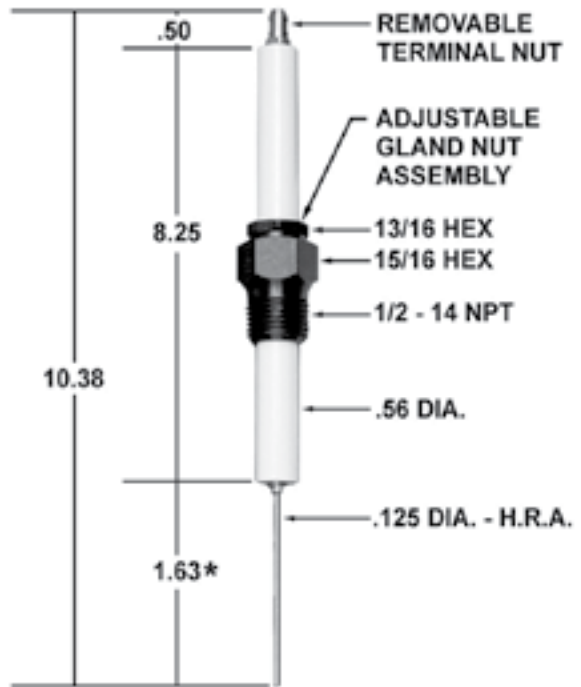

CA310
Replaces Auburn #: IP-17
* NOTE: Other tip lengths are available

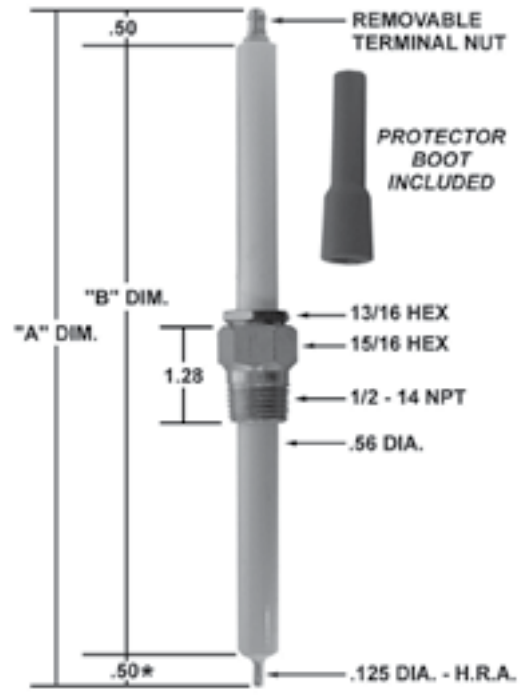

P/N	"A" DIM	"B" DIM	REPLACES
CA311	9.28	8.25	IP-17-1
CA322	7.53	6.50	IP-18-1

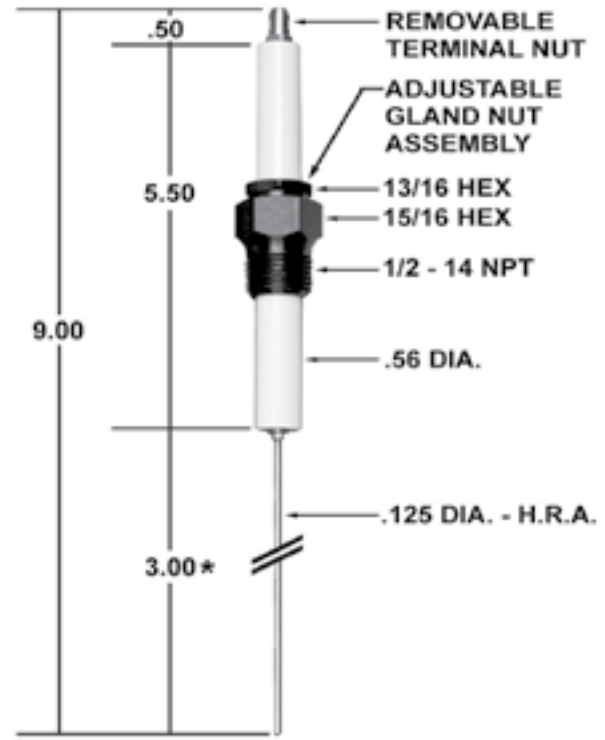

CA330
 Replaces Auburn #: IP-19
 * NOTE: Other tip lengths are available

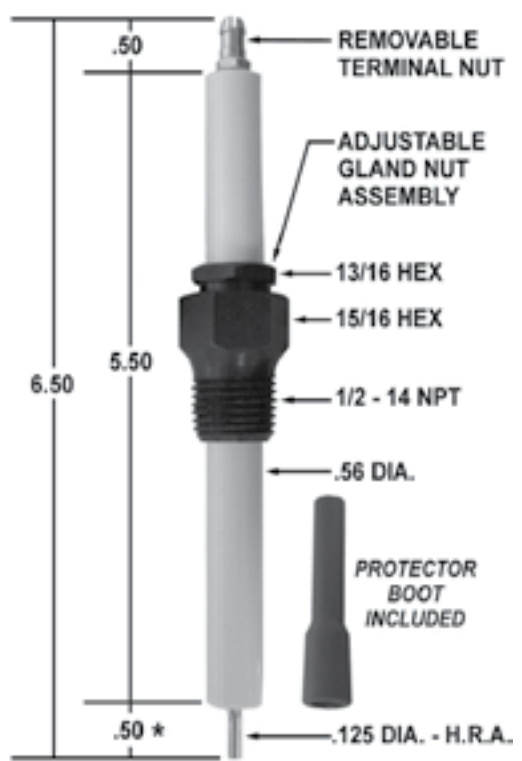

CA331
 Replaces Auburn #: IP-19-1
 * NOTE: Other tip lengths are available

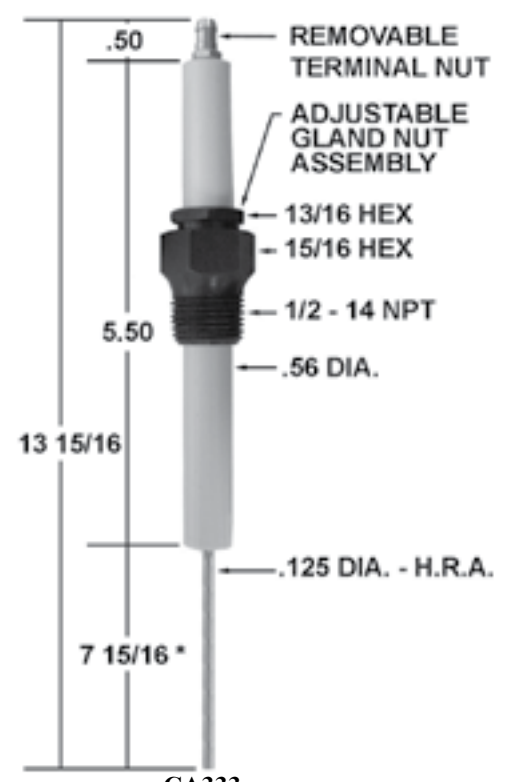

CA333
 Replaces Auburn #: IP-19 with 7 15/16 tip
 * NOTE: Other tip lengths are available

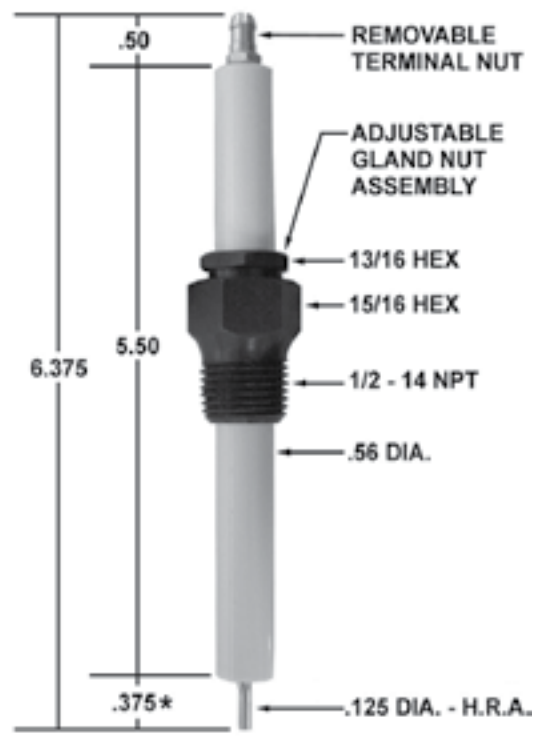

CA341

Replaces Maxon #: 47232
 * NOTE: Other tip lengths are available

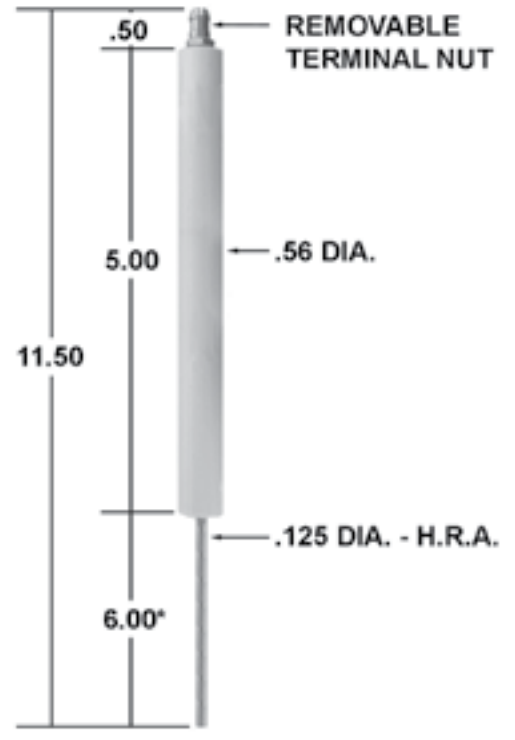

CA350

Replaces Auburn #: IA-16
 * NOTE: Other tip lengths are available

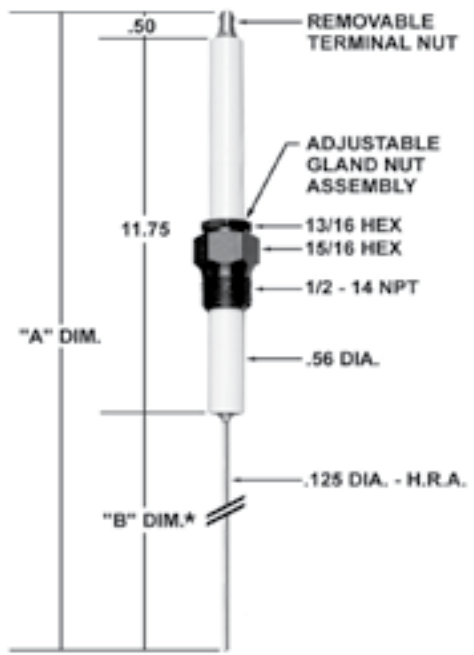

P/N	"A" DIM	"B" DIM	REPLACES
CA370	22.25	10.00	I-5-99
CA377	46.25	34.00	I-5-99-34
CA378	60.25	48.00	I-5-99-48

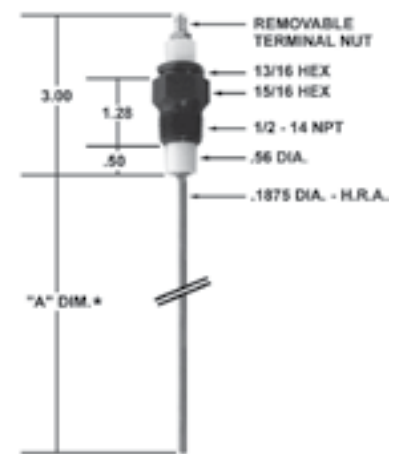

P/N	"A" DIM	REPLACES
CA390	6.00	FRS-2-6
CA391	12.00	FRS-2-12
CA392	18.00	FRS-2-18
CA393	24.00	FRS-2-24
CA394	36.00	FRS-2-36
CA395	42.00	FRS-2-42
CA396	48.00	FRS-2-48
CA397	66.00	FRS-2-66
CA398	72.00	FRS-2-72
CA399	50.00	FRS-2-50



P/N	"A" DIM	"B" DIM	REPLACES
CA490	15.75	6.00	43078
CA410	22.50	12.75	FRS-3
CA411	17.25	8.00	FRS-3 W/8" TIP
CA412	28.00	18.75	1042698

NOTE: OTHER TIP LENGTHS AVAILABLE

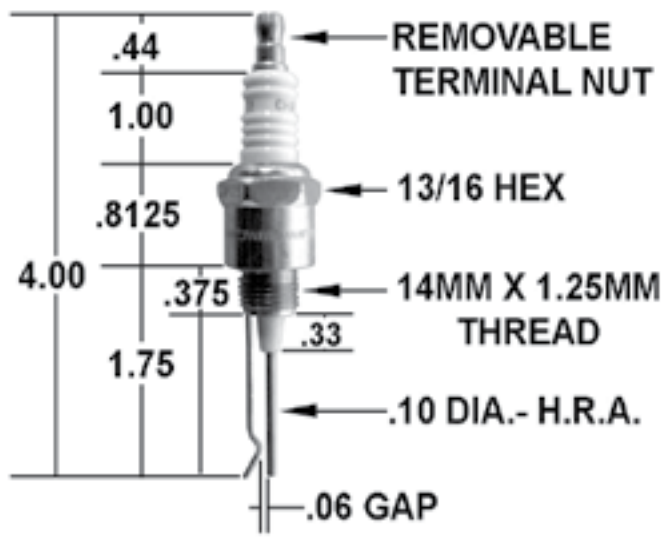
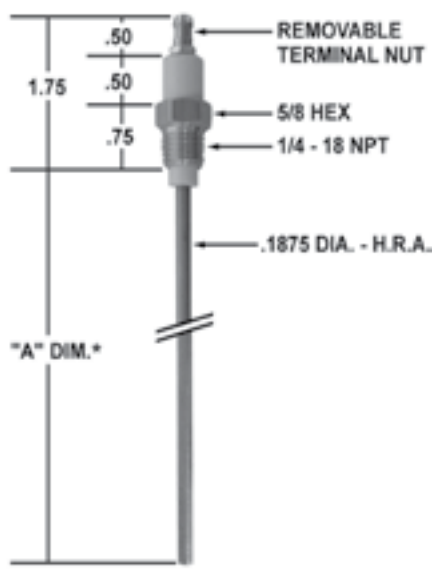
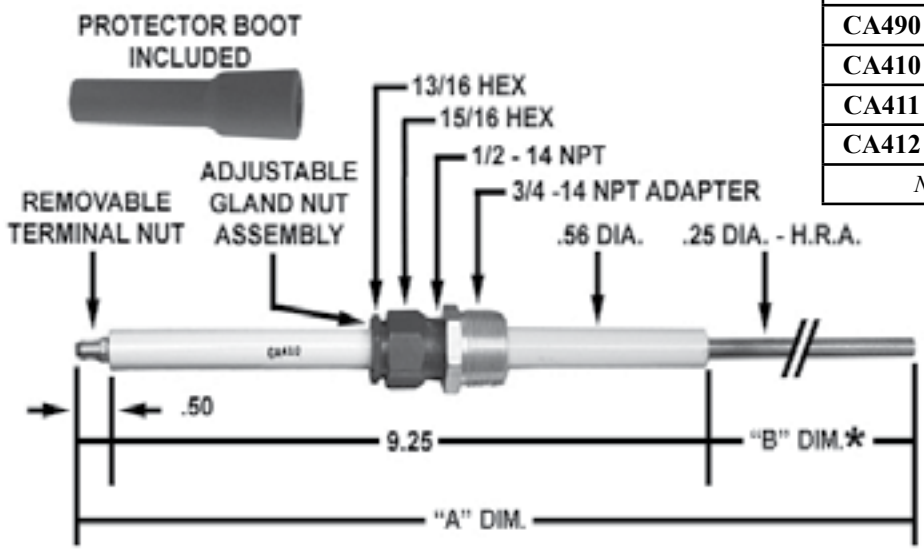

CA470
 Replaces Auburn #: I-3
 95% Alumina Ceramic

P/N	"A" DIM	REPLACES
CA429	1.00	FRS-4-1
CA430	2.00	FRS-4-2
CA431	3.00	FRS-4-3
CA431-1	3.25	FRS-4-3 1/4
CA432	4.00	FRS-4-4
CA433	4.50	FRS-4-4.5
CA434	6.00	FRS-4-6
CA435	7.50	GP-18117
CA436	12.00	FRS-4-12
CA437	18.00	FRS-4-18
CA438	24.00	FRS-4-24
CA439	36.00	FRS-4-36
CA440	48.00	FRS-4-48
CA441	60.00	FRS-4-60

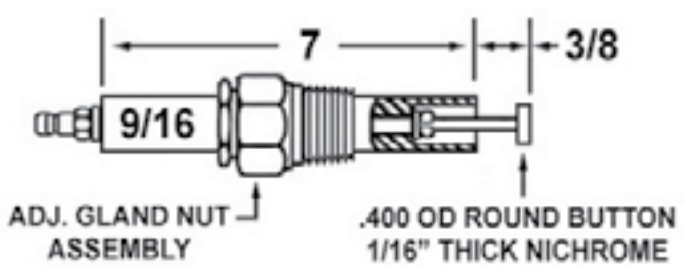

CA345
 Replaces Auburn #: IP-22 & Maxon 54376

Section 3 - Industrial Igniters & Flame Rods

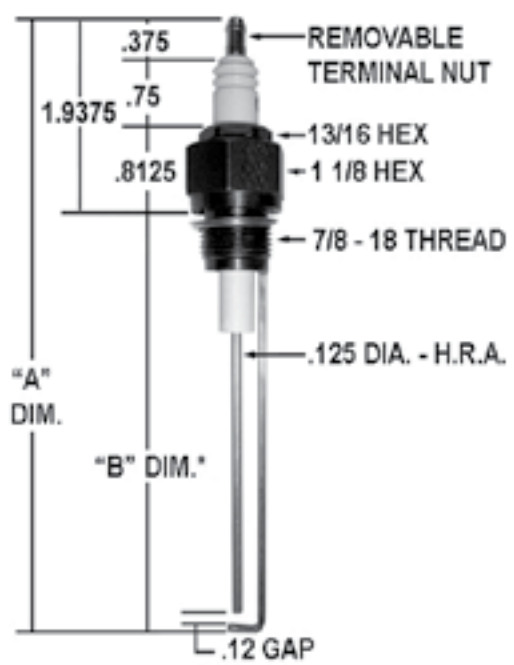
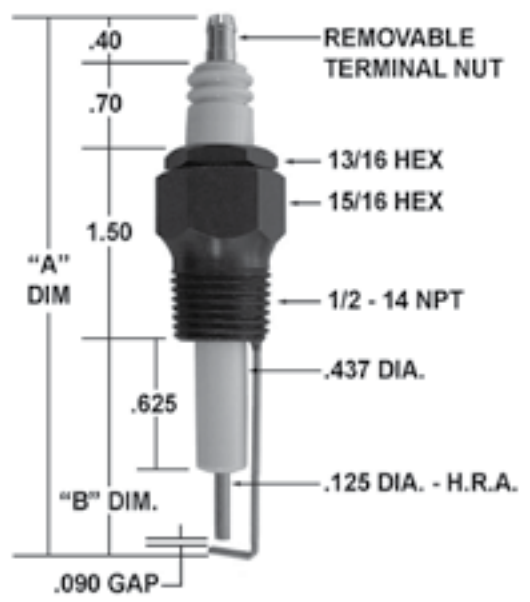

P/N	"A" DIM	"B" DIM	REPLACES
CA475	4.25	1.72	I-64-1
CA476	4.46	1.93	I-64 SPECIAL
CA477	6.39	3.75	I-64-3
CA478	3.75	1.12	I-64-4
CA479	5.10	2.53	I-64-5

P/N	"A" DIM	"B" DIM	REPLACES
CA480	6.50	3.468	IC-9-2
CA481	5.50	2.00	IC-9-4
CA482	5.87	2.375	IC-9-5

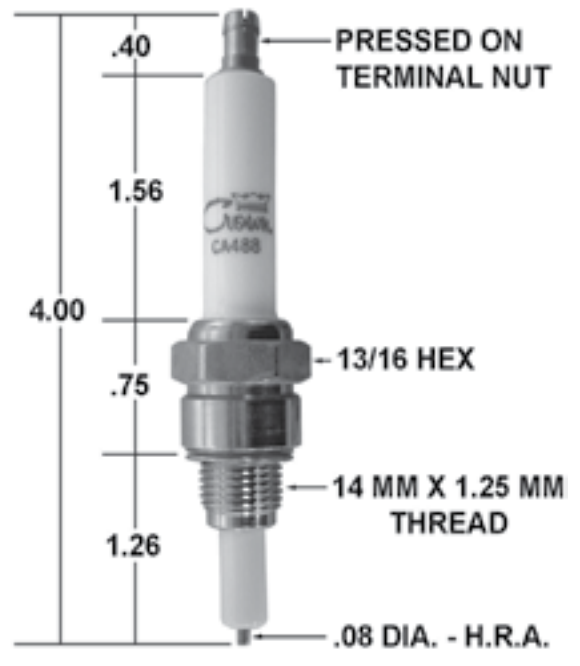

CA485
 Replaces Auburn #: OJ-21-1

CA488
 Replaces Auburn #: OJ-21-4

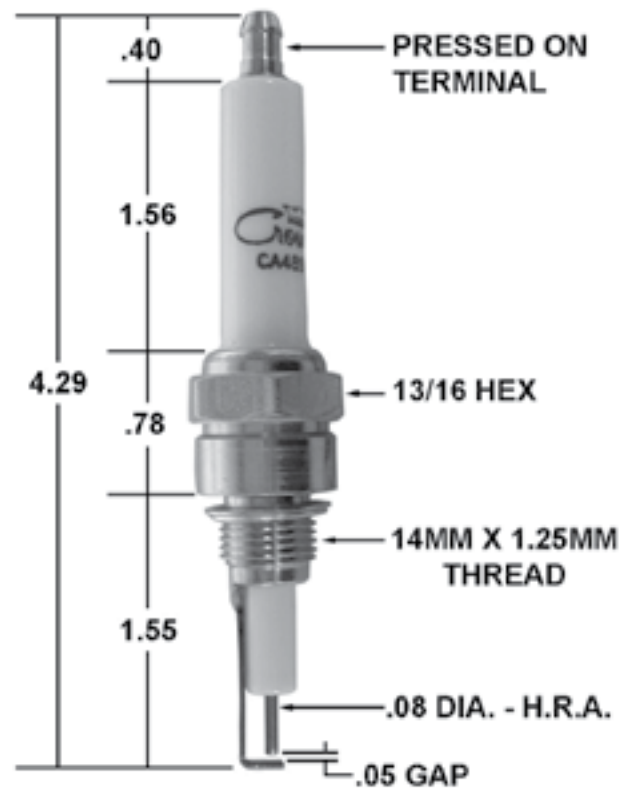

CA489
 Replaces Auburn #: OJ-21-5

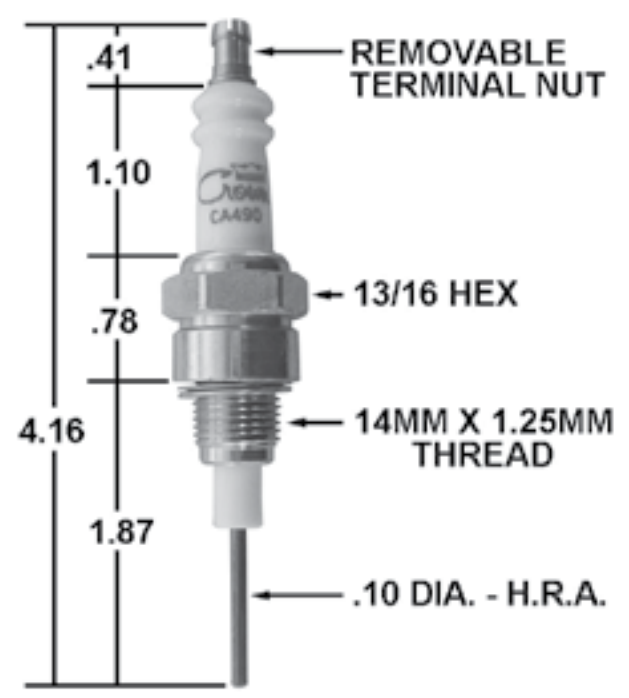

CA490
 Replaces Auburn #: I-33

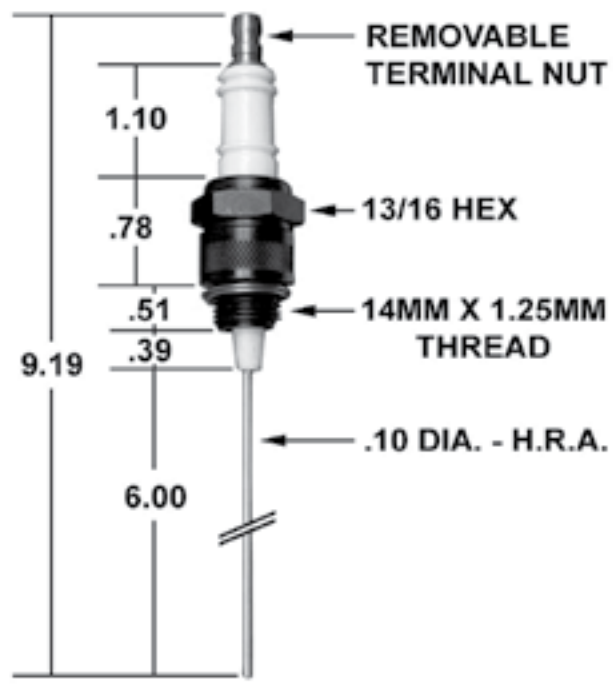

CA496
 Replaces Auburn #: I-33-6



CA500
 Replaces Auburn #: I-101



CA502
 Replaces Auburn #: I-102

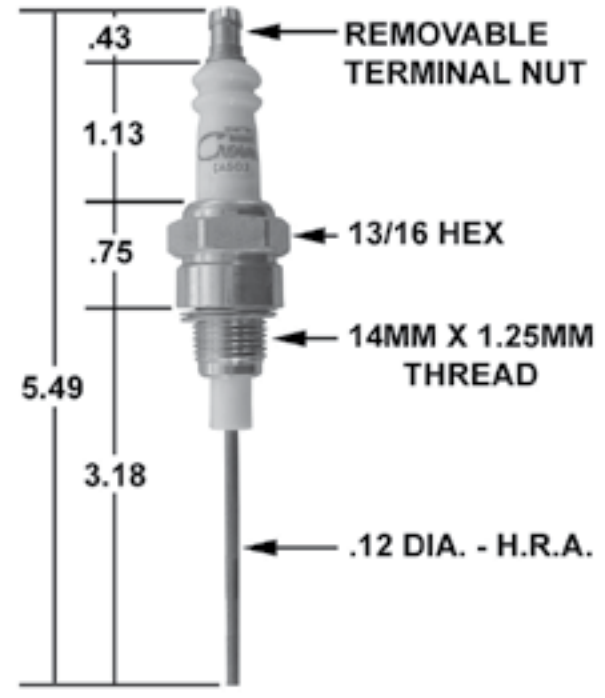

CA503
 Replaces Auburn #: I-143

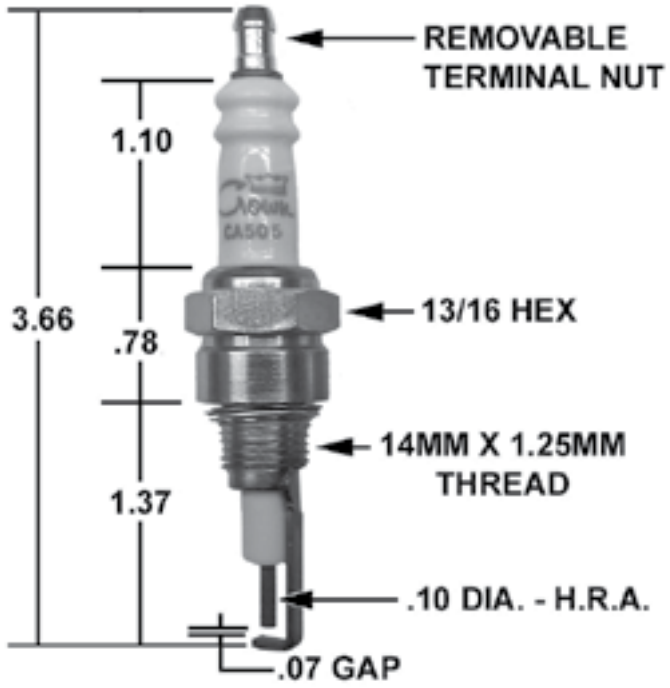

CA505
 Replaces Auburn #: I-31



CA506
 Replaces Auburn #: I-31-1



CA510 & CA512 ARE NO LONGER AVAILABLE
 REPLACE CA510 WITH I-31-5
 REPLACE CA512 WITH ECLIPSE 23045

CA507
 Replaces Auburn #: I-31-2
 and Eclipse #: 16927-1

PART NUMBER	"A" DIM.	"B" DIM.	REPLACES
CA510	6.26	3.97	I-31-5
CA512	6.26	3.97	ECLIPSE 23045

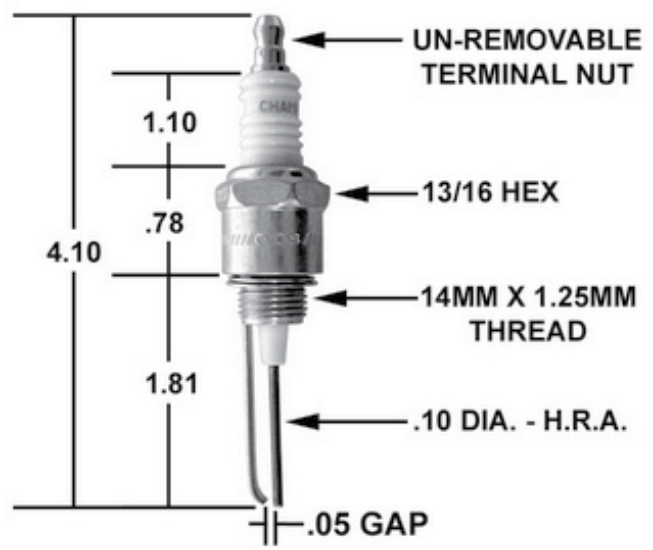

CA515
 Replaces Auburn #: I-32

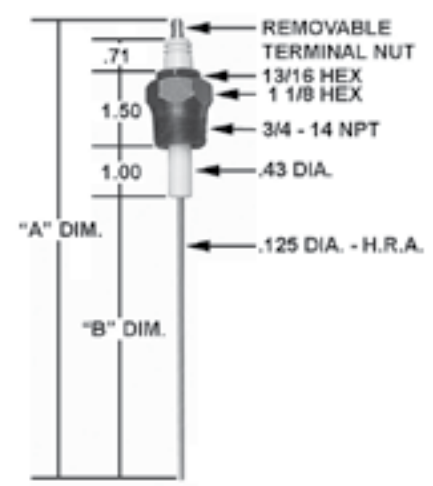

P/N	"A" DIM	"B" DIM	REPLACES
CA520	9.23	5.62	I-34 / 12392
CA522	5.99	2.38	I-34-2.38 / 12392-4
CA526	12.11	8.50	I-34-9.50
CA528	15.23	11.62	I-34-12 / 12392-3
CA529	23.23	19.62	I-34-20
CA530	29.23	25.62	I-34-26 / 12392-1
CA531	39.23	35.62	I-34-36
CA533	57.23	53.62	I-34-54 / 12392-2
CA536	9.61	6.00	I-34-7

Section 3 - Industrial Igniters & Flame Rods

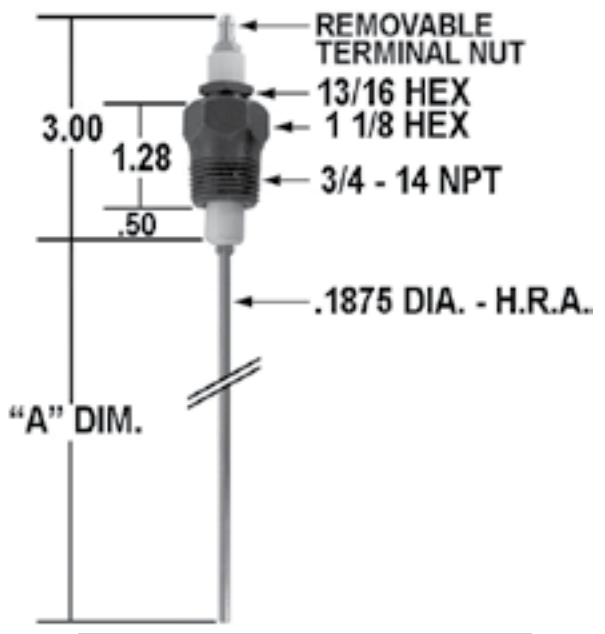

P/N	"A" DIM	REPLACES
CA540	6.00	ECLIPSE 14265-1
CA541	12.00	ECLIPSE 14265-2
CA542	18.00	ECLIPSE 14265-3
CA543	24.00	ECLIPSE 14265-4

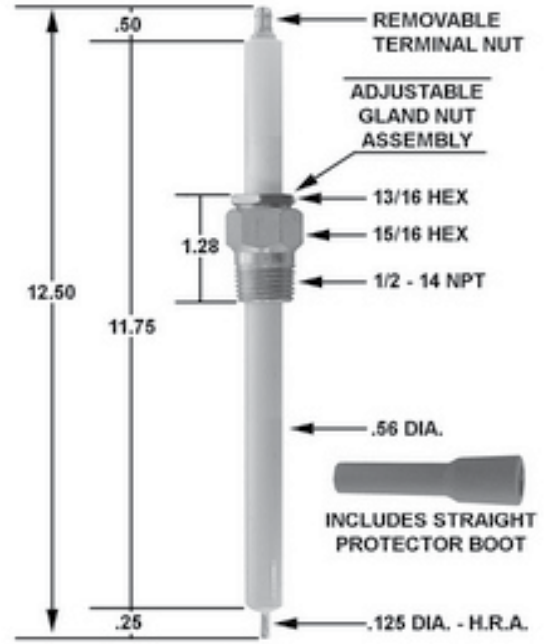

CA566
 Replaces Maxon #: 42148/45979
 * NOTE: Other tip lengths are available

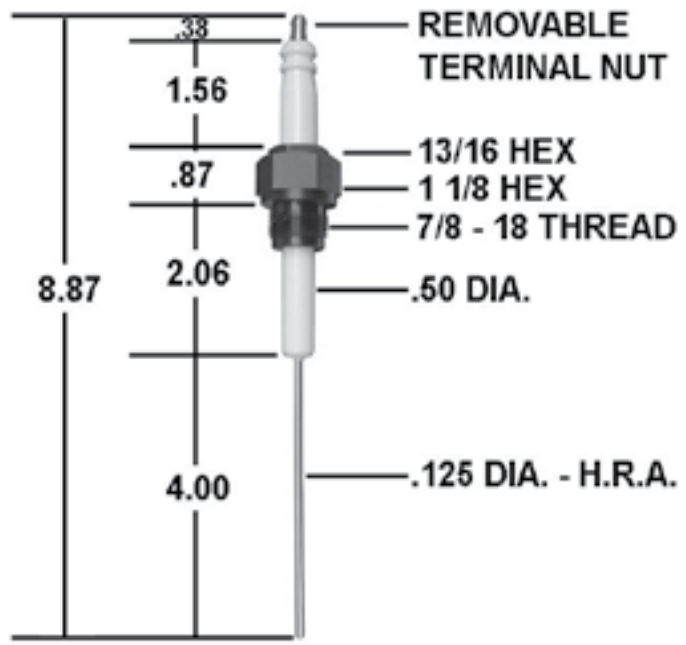

CA607
 Replaces Auburn #: IC-10
 * NOTE: Other tip lengths are available

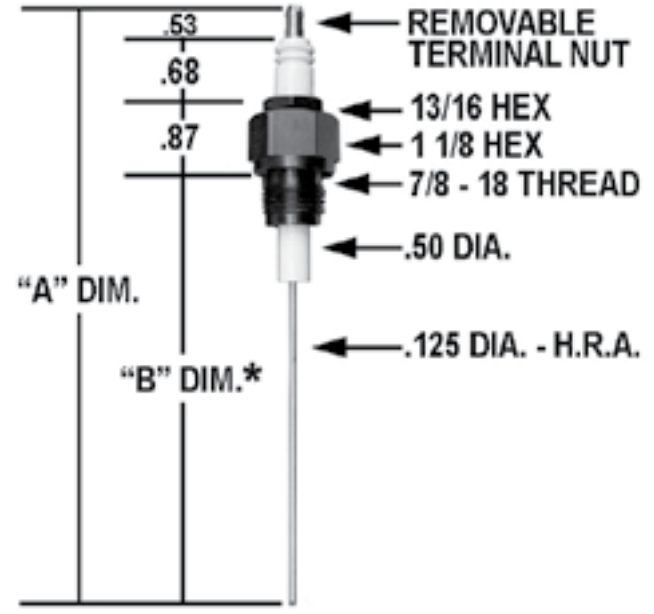

P/N	"A" DIM	"B" DIM	REPLACES
CA611	7.24	5.16	IC-9
CA613	14.08	12.00	IC-9-12
CA625	3.98	1.90	I-78

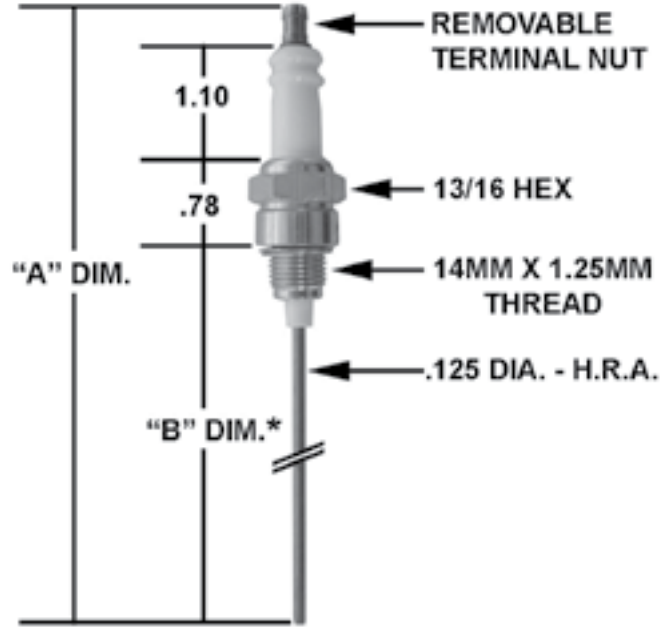
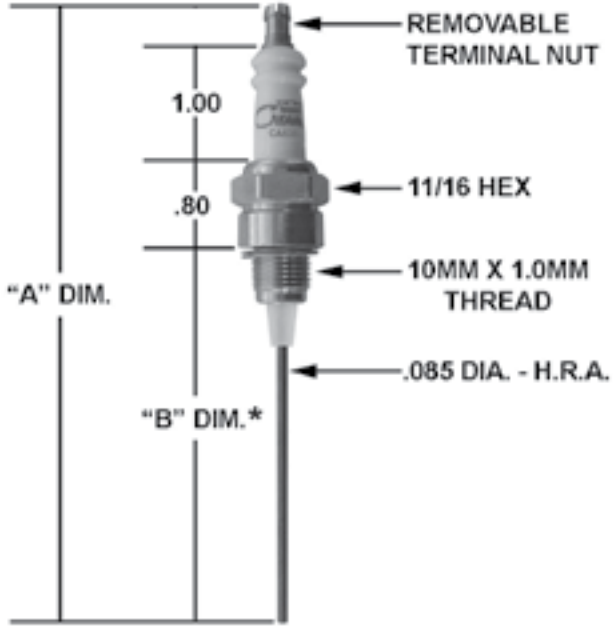

P/N	"A" DIM	"B" DIM	REPLACES
CA635	5.23	3.03	I-10-25
CA636	4.81	2.61	I-10-30-02
CA638	8.73	6.53	I-10-30-6

NOTE: OTHER TIP LENGTHS ARE AVAILABLE

P/N	"A" DIM	"B" DIM	REPLACES
CA645	3.79	1.50	I-144
CA646	12.66	10.37	I-144-1
CA647	14.29	12.00	I-144-12
CA648	23.29	21.00	I-144-21

Industrial Igniter Development Page

While we cannot fathom the idea that you could not find what you were looking for in our standard line of industrial igniters, we will definitely go the extra mile to develop what you need. Our XX-series of specialty igniters are developed daily to meet the needs of "jimmy it, DIY fixes, and imaginative designs," across the globe.

Just fill in the specs, quantity, and fax it over to get price & availability in a snap!

Section 3 - Industrial Igniters & Flame Rods



ENGINEERING CORPORATION

Special Electrode Development Work Sheet

PLEASE ANSWER ALL QUESTIONS & FAX TO: CROWN ENG. CORP. (F) 888-645-7278

1. What is the diameter of the Porcelain / Ceramic Insulator? (Check one box) 7/16" DIA 1/2" DIA 9/16" DIA OTHER _____ DIA
2. What is the length of the Porcelain / Ceramic Insulator? Enter decimal inches or fractional inches only: _____
3. What is the length of the wire from the face of the Porcelain / Ceramic Insulator? _____
4. What is the diameter of the wire or rod? (Check one box): 3/32" DIA 1/8" DIA 3/16" DIA 1/4" DIA OTHER _____ DIA.
5. Is this item going to be used as a (Check one box): Igniter Flame Rod OTHER _____
6. Do you require an adjustable gland nut assembly? (Check one box): YES NO
 If your answer is YES, Please select from the below options:
7. Quantity needed: _____

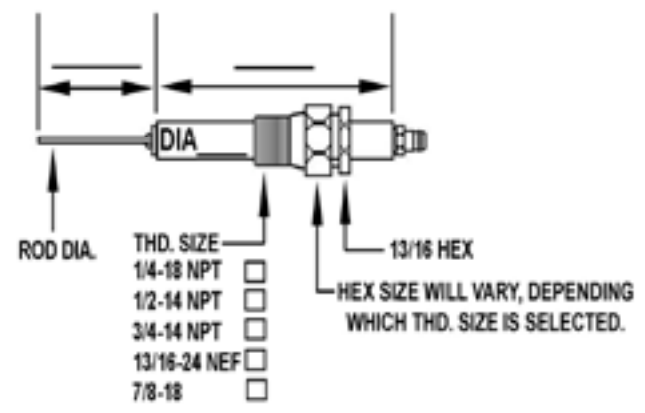

Based on the information that you have supplied, we are pleased to quote as follows:

YOUR COST: _____

LEAD-TIME: _____

USE P/N: _____

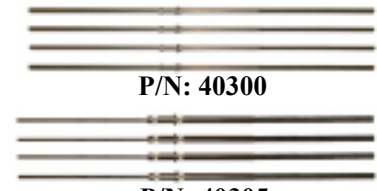

Part Number:
 40300 (1/8" rod dia. X 6-32 Thread)
 40305 (3/16" rod dia. X 10-32 Thread)
 Electrode field replacement rod paks

Packaging: Poly bagged & tagged

Includes: 4 each of one of the above items
 Our electrode rod paks are designed to fit Crown insulators up to 6" in length.
 40300 fits the following ceramic diameters, 7/16", 1/2", and 9/16" with 1/8" key way bore.
 40305 fits the following ceramic diameters, 7/16", 1/2", and 9/16" with 3/16" key way bore.

Section 4 - Electrical

Part Number: 13666
 Honeywell Flame detector - 90° Bracket

Packaging: Boxed

Includes:
 1 - flame detector with 30" lead.
 1 - 90 degree bracket.
 1 - Instruction sheet.
 Used in Wayne burner models
 EH(12"+tubes), HS(12"+ tubes), and FH.



UL file: MP268
UL style: C554A

NOTE: For replacement eyes only see page 69

Part Number: 13667
 Honeywell Flame detector - Str8 bracket

Packaging: Boxed

Includes:
 1 - flame detector with 48" lead.
 1 - Bracket
 1 - Instruction sheet.
 Used in White Rodgers equipment. Replaces Honeywell #C554A-1794. UL recognized and C.S.A. certified.



UL file: MP268
UL style: C554A

Part Number: 13668 (Old P/N: TMK60)
 Honeywell Cad Cell Kit - 6 brackets

Packaging: Boxed

Includes:
 1 - flame detector with 60" lead.
 6 - Brackets.
 1 - Instruction sheet.
 A true universal kit that meets the needs of many burner model applications.
 Replaces Honeywell #C554A-1463.



UL file: MP268
UL style: C554A

Part Number: 14289
 Honeywell Flame detector - 17° bracket

Packaging: Boxed

Includes:
 1 - flame detector with 15" lead.
 1 - 17 degree Bracket.
 1 - Instruction sheet.
 Used in Wayne burner models MEG1, EHS, EG1(3", 6", & 9" tubes), MSR, EH(6" & 9" tubes), EH (Weil-McLain specs), HS, HS(6" & 9" tubes), HS(Weil McLain specs).
 Also used in Bock water heater specs for MSR, EH, & HS.



UL file: MP268
UL style: C554A

BUSS BARS

We stock three types of buss bar connectors available in standard lengths of 6", 8", 10", and 12". Our type "E" and "S" rounded buss bars feature annealed 1/8" diameter 303 Stainless Steel with 6-32 roll threads. Our type "F" flat buss bars feature 3/8" wide X .040 thick 260 brass alloy.

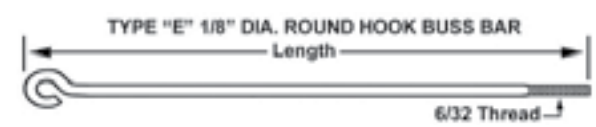

P/N	Length	Type
40309	6" Long	"E" round hook buss bar
40311	8" Long	"E" round hook buss bar
40313	10" Long	"E" round hook buss bar
40315	12" Long	"E" round hook buss bar



P/N	Length	Type
40316	6" Long	"F" flat buss bar
40318	8" Long	"F" flat buss bar
40319	10" Long	"F" flat buss bar
40320	12" Long	"F" flat buss bar

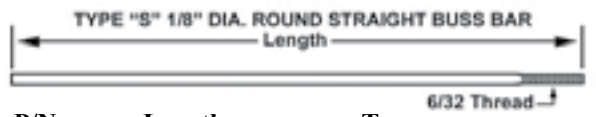

P/N	Length	Type
40322	6" Long	"S" round straight buss bar
40324	8" Long	"S" round straight buss bar
40325	10" Long	"S" round straight buss bar
40326	12" Long	"S" round straight buss bar



Part Number: 41800
 Ignition terminal kit - "Mini-Kit"
Packaging: Sturdy hinged plastic box
Includes:
 20 - 50000 Cage
 12 - 50100 Spring
 20 - 50200 Ring
 10 - 50400 Angle Cage
 12 - 50600 Stud ferrule



Part Number: 41810
 Ignition terminal kit - "Deluxe Kit"
Packaging: Sturdy hinged plastic box
Includes:
 12 - 50000 Cage
 12 - 50100 Spring
 12 - 50200 Ring
 12 - 50400 Angle Cage
 12 - 50600 Stud ferrule
 12 - 50760 6-32 Hex base stud
 12 - 50700 10-32 Hex base stud
 12 - 50860 6-32 Hollow thd. stud
 24 - 50800 10-32 Hollow thd. stud
 12 - 51550 Cage/Cage
 12 - 51630 Cage/Thrd. stud
 12 - 45580 Transformer clip
 12 - 52210 Cage/Buss bar clip
 12 - 52260 10-32 Hex stud
 1 - 40400 Crimping/Rod cutter
 12 - 52340 10-32 Spring
 1 - 40436 Combo ratchet set 1/4" x 5/16"



Part Number: 41805
 Ignition terminal kit - "Transformer kit"
Packaging: Sturdy hinged plastic box
Includes:
 6 - 45580 Transformer clip
 6 - 50800 10-32 Hollow thrd. stud
 6 - 51550 Cage/Cage
 6 - 52210 Cage/Buss bar clip
 6 - 52230 Hex/Buss bar clip
 6 - 52260 10-32 Hex base stud
 6 - 52290 Spring adapter
 6 - 52300 Spring adapter
 4 - 52315 Binding post
 4 - 52340 10-32 Spring contact
 6 - 52350 10-32 Contact post





Part Number: 41813
 Ignition terminal kit - "Build-A-Lead Jr. Kit"

Packaging: Sturdy hinged plastic box

Includes:

- 1 - 40407 Automotive crimp tool
- 10 ft - Hi-temp red silicone cable
- 10 - 50739 90 degree red silicone boots
- 10 - 50740 Straight red silicone boots
- 20 - 61900 Straight automotive terminal connectors
- 20 - 61901 90 degree automotive terminal connectors

Let's get creative! Our "Build-A-Lead Jr. kit has everything you need to create "Johnny on the spot" transformer leads. Create leads at will with our professional crimping tool for beautiful connections on demand!



Part Number: 41814
 Ignition terminal kit - "Build-A-Lead Kit PRO"

Packaging: Sturdy hinged plastic box

Includes:

- 1 - 40408 Ratcheting PRO crimping tool w/attachments
- 10 ft - GTO-15 cable
- 20 ft - Hi-temp red silicone cable
- 10 - 50100 crimp on spring terminals
- 10 - 50500 crimp on angle spring terminals
- 15 - 50739 90 degree red silicone boots
- 15 - 50740 Straight red silicone boots
- 25 - 61900 Straight automotive terminal connectors
- 25 - 61901 90 degree automotive terminal connectors

For the serious PRO! Our "Build-A-Lead PRO Kit," has everything you need to create "Johnny on the spot" transformer leads, high temperature connections and everyday transformer connections. Create leads at will with our professional ratcheting crimping tool for beautiful connections with minimal effort! The tool includes 3 interchangeable jaws for professional automotive crimps, insulated wireless terminal crimps, and uninsulated wireless terminal crimps too!



**Professional Kits.....
 That get the job done!**

Part Number: 41815
 Ignition terminal kit - "Terminal & tool kit"

Packaging: Sturdy hinged plastic box

Includes:

- 24 - 50000 Cage
- 24 - 50100 Spring
- 24 - 50200 Ring
- 24 - 50300 Split ring
- 24 - 50400 Angle cage
- 24 - 50450 Right angle cage
- 24 - 51000 Ferrule/Ferrule
- 100-50900 Eyelets
- 1 - Crimping tool





Igniter Hardware

Section 4 - Electrical

Adapter Bushings - Stainless Steel
 P/N: 45000 - 7/16" ID X 9/16" OD X 1/2" L
 P/N: 45010 - 7/16" ID X 1/2" OD X 1/2" L
 P/N: 45015 - 1/2" ID X 9/16" OD X 3/4" L



Dravo Bushings - Steel
 P/N: 45020 - 9/16" ID X 5/8" OD X 1" L
Ray Bushing - Steel
 P/N: 45220 - 1/2" ID X 3/4" OD X 7/16" L



Aerco Brass Bushing
 P/N: 45029 - 9/16" ID X 3/4" OD X 3/8" L
 P/N: 45030 - 9/16" ID X 3/4" OD X 7/16" L
 P/N: 45033 - .650 OD X .437 ID X .200 L



Brass Bushing
 P/N: 45031 - 1/2" ID X 3/4" OD X 7/16" L
 P/N: 45032 - 7/16" ID X 3/4" OD X 7/16" L



Ray Nylon Shield
 P/N: 45050 - 37/64" ID X 3/4" OD X 7/8" L



Cleaver Brooks Retainer Ring
 P/N: 45150 - 9/16" ID X 23/32" OD



Walter Kidde Buss Bar
 P/N: 45160



Threaded Stud
 P/N: 45170 - 10/32 Thd.
 P/N: 45173 - 6/32 Thd.



Shell Body with Inside Thread
 P/N: 45177 - 13/16 - 24 Thd. X 1" Hex



Shell Body with Outside Thread
 P/N: 45178 - 3/4-20 NEF thd. X 13/16 - 24 NEF Thd. X 1" Hex



Gland Nut for Shell Bodies
 P/N: 45180 - 13/16" Hex X 13/16 - 24 thd.



Shell Body 33/64" hole
 P/N: 45190 - 1/2-14 NPT thd. X 15/16" Hex



Shell Body 39/64" hole
 P/N: 45191 - 1/2-14 NPT thd. X 15/16" Hex



Shell Body with Outside Thread
 P/N: 45192 - 7/8-18 thd. X 1 1/8" Hex



Gland Nut Assembly 3/4 NPT X 1 1/8" Hex
 P/N: 45194 - Fits over 9/16" DIA. insulators



Gland Nut Assembly 1/2-14 NPT Thread
 P/N: 45195 - Fits over 9/16" DIA. insulators

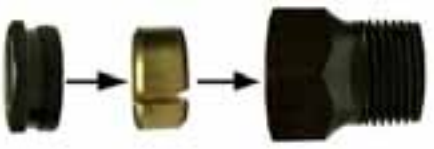

Reducer Bushing
 P/N: 45196 - 3/4" NPT to 1/2" NPT









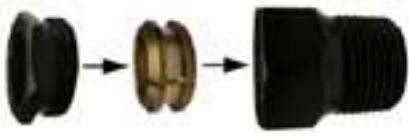

Shell Body with Outside Thread
 P/N: 45197 - 13/16-24 thd. X 1" Hex

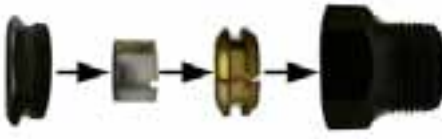



Igniter Hardware

<p>Shell Body with Outside Thread P/N: 45198 - 3/4 NPT X 1 1/8" Hex</p> 	<p>Gland Nut Assembly 1/2-14 NPT Thread P/N: 45199 - Fits over 1/2" DIA. insulators</p> 	<p>Copper Washer for 9/16 DIA. insulator P/N: 45200 - 9/16" ID X 3/4" OD X .032 tk.</p> 
<p>Copper Washer for 1/2 DIA. insulator P/N: 45201 - 1/2" ID X 23/32" OD X .032 tk.</p> 	<p>Gland Nut Assembly 1/2-14 NPT Thread P/N: 45202 - Fits over 7/16" DIA. insulators</p> 	<p>Copper Washer for 7/16 DIA. insulator P/N: 45203 - 7/16" ID X 11/16" OD X .032 thick.</p> 
<p>Gordon-Piatt Copper Filled Gasket P/N: 45292 - .575 ID X .740 OD X .075 tk.</p> 	<p>M-Honeywell Holder - .875 ID P/N: 45221 - .875 Pipe ID & .825 Elec. ID</p> 	<p>Brass NPT Adapter - 1/8 to 1/4 NPT P/N: 45293 - 9/16" Hex X 1/4 NPT</p> 
<p>Brass NPT Adapter - 1/4 to 1/8 NPT P/N: 45294 - 5/8" Hex X 1/8 NPT</p> 	<p>Brass Hex Stud Adaptor P/N: 45300 - .1/4" Hex X 10/32 Thread</p> 	<p>Need a special part or combination of parts? Why not give us a call? We would love to quote your requirements!</p>

Cad Cell Eyes

Part Number: 45610
 Flame detector cad cell eyes - C-10

Packaging: Carded - 5 per card

Includes:

Our flame detectors are hand crafted and tested twice.

Once before assembly, and after. Look for them in our attractive strip packaging. Ideal POP area's.

Please order in increments of 5.

A direct replacement in the Honeywell C554A, Honeywell replacement cell part numbers 130367, 120320 and 124607.



Specifications

- Maximum Voltage: 30 VAC
- Maximum Resistance: Min. 300 OHMS
- During Firing: Max. 1,600 OHMS
- Max. Cell Surface Temp: 180° F
- Method of Sensing: Cadmium Sulfide



Terminal Connectors / Rajah Style

Section 4 - Electrical

CAGE 50000	SPRING 50100	RING 50200	HOOK 50250	ANGLE / CAGE 50400	RIGHT ANGLE CAGE 50450
ANGLE SPRING 50500	STUD FERRULE 50600	HEX BASE STUDS 10-32 THD. 50700 6-32 THD. 50760 8-32 THD. 50780	LONG HEX BASE STUDS 10-32 THD. 50751 6-32 THD. 50761	HOLLOW THD. STUDS 10-32 THD. 50800 6-32 THD. 50860 8-32 THD. 50880	CAGE / CAGE 51550
SPRING / SPRING 51560	CAGE / THD. STUD 10-32 THD. X 3/8" L 51630	SPRING / STUD 6-32 THD. X 1 1/8" L 51711 10-32 THD. X 3/8" L 51730	ANGLE SPRING / STUD 10-32 THD. X 3/8" L 51753	SPRING / HEX BASE 10-32 THD. 51900 6-32 THD. 51960	TERMINAL THUMB NUT 10-32 THD. 52200
CAGE / BUSS BAR CLIP 52210	SPRING / BUSS BAR CLIP 52220	HEX BASE / BUSS BAR CLIP 10-32 THD. 52230	LONG HEX BASE / BUSS BAR CLIP 10-32 THD. 52235	SHORT HEX STUD 10-32 THD. 52260 3-56 THD. 52263 6-32 THD. 52266	BECKETT SPRING ADAPTER 52285
SHORT "A" SPRING 52290	SPRING ADAPTER 52300	SPRING / BINDING POST 52315	CAGE / BINDING POST 52316	CONTACT POST 10-32 THD. 52350	KNURLED CONTACT POST 10-32 THD. 52355
SHORT "Y" SPRING 52365	LONG "Y" SPRING 52366	HOOK / HEX BASE 10-32 THD. 52440	SPRING / DRILLED FERRULE .096 DIA. HOLE 52571	ANGLE SPRING / DRILLED FERRULE .096 DIA HOLE 52641	CAGE / CONTACT POST 52810



Terminal Connectors / Rajah Style

					
CAGE / HEX BASE BUSS BAR CLIP 52830	CAGE / SHORT HEX BASE STUD 52840	CAGE / SHORT "A" SPRING 52850	CAGE / ADAPTER SPRING 52860	RIGHT ANGLE CAGE / CAGE 52880	SLOTTED HEX BASE STUD 6-32 THD. 52891
					
SMALL THUMB NUT 10-32 THD. 52900	CAGE / LARGE THUMB NUT 52915	SPRING / LARGE THUMB NUT 52916	CAGE / WEBSTER CLIP 52920	HEX BASE STUD / SHORT NYLON 55001	STUD / ANGLE NYLON CAP 55011
					NEED A CUSTOM MADE TERMINAL? CALL US..... WE CAN HELP.
BASE STUD / SOLDERLESS BRASS FERRULE 55021	SOLDERLESS RING / SHORT CAP #10 HOLES 55101	SOLDERLESS RING / SHORT CAP .250 HOLE 55102	RING / SOLDERLESS BRASS FERRULE 55121	SOLDERLESS SPRING / SHORT NYLON CAP 55201	
					
SPRING / ANGLE NYLON CAP 55211	SPRING / SOLDERLESS BRASS FERRULE 55221	SPRING / EXTENDED NYLON CAP 55231	SOLDERLESS ANGLE SPRING / SHORT CAP 55301	ANGLE SPRING / SOLDERLESS BRASS FERRULE 55321	

Terminal Packaging Note

Please note that most of the terminal connectors listed on pages 70 through 71 are packaged in 10 and 50 packs.
 To order a 10 pack simply add the suffix -10 after the 5 digit part number.
 For a 50 pack add a -50.

Part Number: TCK - 1

Transformer contact kit
Packaging: Poly bag & tagged
Includes:
 2 - 45580 Contact buss bar clips
 2 - 60010 #10 Split lock washer
 2 - 60999 #10 Flat washer
 2 - 60022 10-32 Hex nut

Can be used in a variety of applications and equipment.





Solderless Wire Terminals & Kits

Section 4 - Electrical

 P/N: 61850 #6 RING TERMINAL 22-18 WIRE SIZE 4-6 STUD SIZE	 P/N: 61854 #8 RING TERMINAL 22-18 WIRE SIZE 8 STUD SIZE	 P/N: 61855 #10 RING TERMINAL 22-18 WIRE SIZE 10 STUD SIZE	 P/N: 61856 #6 RING TERMINAL 16-14 WIRE SIZE 4-6 STUD SIZE	 P/N: 61857 .250 RING TERMINAL 22-18 WIRE SIZE 1/4" STUD SIZE	 P/N: 61858 #10 RING TERMINAL 16-14 WIRE SIZE 10 STUD SIZE
 P/N: 61859 #6 SPADE TERMINAL 22-18 WIRE SIZE 4-6 STUD SIZE	 P/N: 61861 #10 SPADE TERMINAL 22-18 WIRE SIZE 10 STUD SIZE	 P/N: 61862 #6 SPADE TERMINAL 16-14 WIRE SIZE 4-6 STUD SIZE	 P/N: 61863 .250 FEMALE TAB 22-18 WIRE SIZE .250 OD	 P/N: 61864 #10 SPADE TERMINAL 16-14 WIRE SIZE 10 STUD SIZE	 P/N: 61866 .250 MALE TAB 16-14 WIRE SIZE .250 X .032 SIZE
 P/N: 61867 .250 MALE TAB 22-18 WIRE SIZE .250 OD	 P/N: 61868 .250 FEMALE TAB 16-14 WIRE SIZE .250 ID	 P/N: 61871 #8 RING TERMINAL 16-14 WIRE SIZE 8 STUD SIZE	 P/N: 61872 .250 RING TERMINAL 16-14 WIRE SIZE 1/4" STUD SIZE	 P/N: VBC1614 BUTT CONNECTOR 16-14 WIRE SIZE	 P/N: VBC2218 BUTT CONNECTOR 22-18 WIRE SIZE

Part Number: 41881
 Terminal Kit - "Big Box"
Packaging: Sturdy Hinged Box
Includes:
 1 - Big Box containing all of the terminals listed on this page
 Each compartment contains 50 each of the above terminal connectors that are the most popular in our industry.
 1 - Each 40401 8mm/terminal crimping tool
 3 - Each 6" long 1/8" fuel resistant shrink tube
 3 - Each 6" long 1/4" fuel resistant shrink tube
 And when you empty out a compartment just re-order using the above part numbers and add the suffix -50 and you are re-stocked in a snap! The heavy duty high impact case protects and organizes your parts for ease of use.

NEW
BIG BOX





Hi-Temp Wire Leads

Part Number: 70043-02

Cable leads for Weil-McLain

Packaging: Poly bagged & tagged

Includes:

1 - Set of wire leads

Original OEM replacement leads for Weil-McLain models QB180 & 300. Weil-McLain P/N: 644-600-043. This lead features a .125 round female rod connector on one end and a 1/4" female spade connector on the other. Both crimped connections are protected by a 1" long oil resistant shrink tube.

Specifications:

- 11 3/4" Over all length
- 20KVDC
- 150° C / 302° F



Part Number: 70071

Cable leads for Honeywell

Packaging: Poly bagged & tagged

Includes:

1 - 7mm Wire lead per bag

Crown generic replacement for Honeywell #:392125-2

These hi-temp rated leads offer a 90° automotive type connector on one end and a straight automotive type connector on the other end.

Specifications:

- 36" Over all length - 18 AWG - 25KVDC / 10KV / 60 HZ - 250° C / 482° F - UL FILE: E-96824 - UL STYLE: 3257



Part Number: 70070

Cable leads for Honeywell

Packaging: Poly bagged & tagged

Includes:

1 - 7mm Wire lead per bag

Crown generic replacement for Honeywell #:394800-30.

These hi-temp rated leads offer a 90° automotive type connector on one end and a 1/4" female insulated tab on the other end.

Specifications:

- 30" Over all length - 18 AWG - 25KVDC / 10KV / 60 HZ - 250° C / 482° F - UL FILE: E-96824 - UL STYLE: 3257



Part Number: 70072

Cable leads for Honeywell

Packaging: Poly bagged & tagged

Includes:

1 - 7mm Wire lead per bag

Crown generic replacement for Westwood #:E64-5

These hi-temp rated leads offer a 90° automotive type connector on one end and a straight automotive type connector on the other end.

Specifications:

- 33 1/2" Over all length - 18 AWG - 25KVDC / 10KV / 60 HZ - 250° C / 482° F - UL FILE: E-96824 - UL STYLE: 3257





Twisted Rope - High Temp.

Our ceramic fiber rope is a twisted three-ply rope made to meet tough industrial standards, **2300 degrees fahrenheit (1260 degrees centigrade)**. Typical uses include gasketing, packing and sealing applications. Our rope exhibits excellent chemical stability, resisting attack from most corrosive agents. Exceptions are Hydrofluoric and Phosphoric acids and concentrated alkalis. They also resist Oxidation and Reduction. If wet by water or steam, thermal and physical properties are completely restored upon drying. No water hydration is present.

Ceramic High Temperature Asbestos Free Twisted Rope



DIA	FT / CARTON	P/N
1/4"	45'	14FR45
1/4"	90'	14FR90
1/4"	900'	14FR900
3/8"	25'	38FR25
3/8"	50'	38FR50
3/8"	500'	38FR500
1/2"	15'	12FR15
1/2"	30'	12FR30
1/2"	300'	12FR300
5/8"	Sold per foot	58FR
3/4"	Sold per foot	34FR
1"	Sold per foot	1FR
1 1/4"	Sold per foot	114FR
1 1/2"	Sold per foot	112FR
2"	Sold per foot	2FR

Braided Rope - High Temp.

Our ceramic fiber braided rope is a tightly knitted braid that keeps it's form under the most extreme applications. It won't unravel or flatten and is easy to cut.

Constant operating temperature of 2300 degrees fahrenheit (1260 degrees centigrade). Typical uses include gasketing, packing and sealing applications. Our rope exhibits excellent chemical stability, resisting attack from most corrosive agents. Exceptions are Hydrofluoric and Phosphoric acids and concentrated alkalis. They also resist Oxidation and Reduction.

Ceramic High Temperature Asbestos Free Braided Rope



DIA	FT / CARTON	P/N
1/4"	45'	14FRB45
1/4"	90'	14FRB90
1/4"	900'	14FRB900
3/8"	15'	38FRB15
3/8"	25'	38FRB25
3/8"	400'	38FR400
1/2"	15'	12FRB15
1/2"	30'	12FRB30
1/2"	300'	12FRB300
5/8"	Sold per foot	58FRB
3/4"	Sold per foot	34FRB
1"	Sold per foot	1FRB
1 1/4"	Sold per foot	114FRB
1 1/2"	Sold per foot	112FRB
2"	Sold per foot	2FRB



Fiberglass Tape

Part Number(s):
 FG1X116A (1" W X 1/16" T X 100' Roll w/adhesive)
 FG1X18 (1" W X 1/8" T X 100' Roll)
 FG1X18A (1" W X 1/8" T X 100' Roll w/adhesive)
 FG1X14 (1" W X 1/4" T X 100' Roll)
 FG1X14A (1" W X 1/4" T X 100' Roll w/adhesive)
 FG112X18 (1 1/2" W X 1/8" T X 100' Roll)
 FG112X18A (1 1/2" W X 1/8" T X 100' Roll w/adhesive)
 FG112X14 (1 1/2" W X 1/4" T X 100' Roll)
 FG112X14A (1 1/2" W X 1/4" T X 100' Roll w/adhesive)
 FG2X18 (2" Wide X 1/8" Thick X 100' Foot Roll)
 FG2X18A (2" W X 1/8" T X 100' Roll w/adhesive)
 FG2X18BH (2" W X 1/8" T X 100' W with bolt holes)

Fiberglass tape

Packaging: Shrink wrapped - 100' roll.

Includes:
 1 - 100' roll of one of the above selected sizes.
 Flex-Tape has a **temperature rating of 1000° F (538° C)**.
 Flex-Tape is a knitted fiberglass tape manufactured from textured fiberglass yarn. It contains no compounds, cement, or wire. The knitting process includes a non-fraying edge.

Applications include:
 Used in ovens, furnaces and boilers as a door seal, as pipe wrapping in such applications as steam tracer lines, as tadpole tape gasket covering material, and in many other gasket and insulation applications.



Part Number (s):
 48001 - 1' x 50' roll
 48002 - 2' x 50' roll
 48004 - 3' x 50' roll
 48006 - 4' x 50' roll

Fiberfrax® 440J gasket paper

Packaging: Plain corrugated carton

Includes:
 1 - roll of 1/8" thick 440J gasket paper of selected size.
 Fiberfrax® 440J paper is a commercial grade, paper made from a combination of ceramic fiber, inert fillers and fiberglass to produce an exceptionally strong sheet for use up to 704 degrees Centigrade/1300 degrees Fahrenheit. Ideal for gasketing applications. Its easy to handle and can be cut, wrapped and rolled.



Ceramic Fiber Blankets

Part Number(s):
 48015 (1/2" T X 24" W X 25' L)
 48016 (1/2" T X 48" W X 25' L)
 48017 (1" T X 24" W X 25' L)
 48018 (1" T X 48" W X 25' L)
 48019 (1 1/2" T X 24" W X 17' L)
 48020 (1 1/2" T X 48" W X 17' L)
 48021 (2" T X 24" W X 12 1/2' L)
 48022 (2" T X 48" W X 12 1/2' L)
 48023 (1" T X 24" W X 25' L Zirconia Grade)
 48024 (1" T X 48" W X 25' L Zirconia Grade)

Ceramic fiber blanket

Packaging: Carton

Includes:
 1 - roll of one of the above selected sizes.
 Our TaoFibre® Ceramic Fiber Blankets are spun ceramic fiber blanket, which are lightweight and thermally efficient, resulting in a material that possesses the advantages of low heat storage and complete resistance to thermal shock. Used in a variety of heat processing applications, the ceramic fiber blanket is produced from high strength spun ceramic fibers and is needed to provide exceptional handling strength. The ceramic fiber blanket is completely inorganic and is available in a variety of thicknesses, and widths. Our blankets are comparable to Durablanket® S & HP-S and our Zirconia grade is comparable to Durablanket® 2600. All of our blankets have an average tensile strength of 8 pcf. density (11.60 psi).
 Part # 48015 to 48022 **max. temp.rating 2300° F (1260° C)**.
 Part # 48023 to 48024 **max. temp.rating 2600° F (1426° C)**.
NOTE: UPS up-charge applies due to carton dimensions.

Applications include:

- Furnace, klin, and boiler linings
- Casting mold wrappings
- Flexible high-temperature pipe insulation
- Furnace door linings and seals
- Furnace repairs
- Expansion joint seals
- Wrapping insulation





Part Number(s):

- 48101 (12 per case 1/2" Tk. X 2' X 3' LD) *
- 48102 (6 per case 1" Tk. X 2' X 3' LD)
- 48103 (4 per case 1 1/2" Tk. X 2' X 3' LD)
- 48104 (3 per case 2" Tk. X 2' X 3' LD)
- 48105 (4 per case 1" Tk. X 2' X 4' LD)
- 48106 (6 per case 1/2" Tk X 3 1/2' X 4' LD)
- 48107 (8 per case 1/2" Tk X 2' X 4' LD)
- 48108 (2 per case 2" Tk X 2' X 4' LD)
- 48125 (24 per case 1/4" Tk. X 2' X 3' HD)
- 48131 (12 per case 1/2" Tk X 2' X 3' HD)

Refractory boards

Packaging: Corrugated carton

Includes:

1 case of LD or HD fiberboards from the above list.
 Our TaoFibre® high temperature ceramic fiber boards feature high temperature stability, low thermal conductivity, even density, and excellent resistance against thermal shock and chemical attack. TaoFibre® ceramic fiber board also resists oxidation and reduction. If they are wet by water, steam, or oil, physical and thermal properties are fully restored upon drying. Ceramic Fiber board is used for a variety of high temperature applications, including refractory linings, backup insulation, baffles and muffles, heat shields, combustion chambers, flue insulation, and fire protection. These ceramic fiber boards are low density for easy cutting and have a continuous temperature rating of 2300° F / 1260° C.

*NOTE: This item must ship via UPS Freight service to prevent shipping damage, or freight disclaimer signature required.

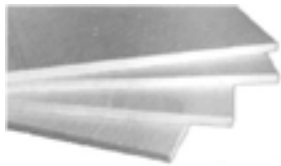

Original replacement gaskets for Beckett, Carlin, & Wayne burners

The below gaskets are the original OEM gaskets for the below specified burners.

Guaranteed to work in the application! For gasket specifications please contact the OEM directly.

Part Number: 100428

Wayne flange gasket HS HSR HSG

Dimensions: 7 1/2" OD X 4" ID

Used in models: HS, HSR, & HSG



Part Number: 12484

Wayne flange gasket EH EASR EHA

Dimensions: 7 3/8" OD X 4 5/16" ID

Used in models: EH, EASR, & EHA



Part Number: 3616

Beckett flange gasket - Universal

Dimensions: 8 1/2" OD X 3 15/16" ID

Used in models: Universal



Part Number: 3811

Beckett flange gasket #68 W-M Boilers

Dimensions: 6 1/4" L X 6 1/4" W

Used in models: Used in #68 Weil-McLain boilers.



Part Number: 5432

Beckett flange kit AF,AFG,SR,SF, & SMG

Packaging: Poly bagged & tagged

Includes: 1 ea. Flange & 1 ea. Gasket (3616)

Fits models AF,AFG,SR,SF, & SMG.



Part Number: 75016

Carlin flange gasket #40287

Dimensions: 8" OD X 3 1/8" ID

Used in models: 99-101 CRD, G3 & EZ1



Part Number: 70203 - 11 oz. caulking tube

Ceramic putty - Thermeez®

Packaging: Bulk

Includes:

1 - 11 oz. tube of Thermeez ceramic putty
 Thermeez is made of a high purity, asbestos free, aluminum oxide based ceramic with a melting point in excess of 3200° F. **It has a continuous service temperature of 3000° F.** Use for instant repairs to brick, mortar, burner blocks, insulation, furnace holders, thermocouples, etc...just apply and let dry!. Resistant to molten metals, most chemicals, oxidizing, and reducing atmospheres.
 Cures in 24 hours at room temperature. Drying process can be accelerated by using a heat gun for emergency repairs. This product has a 8 - 12 month shelf life.

Properties

- Base.....AL203
- Loss factor.....0.017
- Continuous service.....3000°F
- Melting point.....3200°F
- Density.....40 - 50#/ft.³
- Specific heat.....0.25 BTU/#°F
- Dielectric constant @ 10³ CPS.....1.61
- Dielectric strength.....100 volts/mil.
- Freezing point.....32°F
- Thermal conductivity*.....0.65
- *BTU/Hr.°F ft. @ 500°F





Burner Gaskets - Assorted

We make a wide variety of generic gaskets for a variety of burners. These gaskets are made of a 1/8" thick white non-asbestos material and have a continuous operating temperature of 2300 degrees fahrenheit.

Part Number: 75000
 Miller large pouch gasket
Dimensions: 16"L X 10 1/2"W
Used in models: CMF, MOC, & MGC
 Miller #: 301205000



Part Number: 75007
 Universal gasket - No bolt holes
Dimensions: 8"OD X 4"ID
Used in models: Universal



Part Number: 75001
 Miller small pouch gasket
Dimensions: 13 5/8"L X 10"W
Used in models: MMG82
 Miller #: 301181000



Part Number: 75008
 Utility gasket roll
Dimensions: 25 Ft. X 1" Wide
Used in models: Universal



Part Number: 75002
 Miller burner flange gasket
Dimensions: 6 1/2"OD X 4 1/4"ID
Used in models: CMF, & MOC
 Miller #: 300001000



Part Number: 75009
 Carlin flange gasket 1150
Dimensions: 12"OD X 10"ID
Used in models: 1150



Part Number: 75003
 Riello air tube gasket
Dimensions: 5 1/4"L X 5 1/4"W
Used in models: Universal



Part Number: 75010
 Carlin flange gasket 1050
Dimensions: 11"OD X 8 3/4"ID
Used in models: 1050



Part Number: 75004
 Thermo Pride cover gasket
Dimensions: 4"OD X 3/8"ID
Used in models: Universal



Part Number: 75011
 Carlin flange gasket 801 PF
Dimensions: 11"OD X 5 1/4"ID
Used in models: 801 Pressure fired



Part Number: 75005
 G. E. Door Gasket
Dimensions: 10"OD X 8"ID
Used in models: Universal



Part Number: 75012
 Carlin flange gasket 201-701 CRD
Dimensions: 10"OD X 4 1/8"ID
Used in models: 201, 301, 501, 601 & 701 Pressure fired CRD



Part Number: 75006
 Cover gasket - Heil / Bradford / Olsen
Dimensions: 3"OD X 2"ID
Used in models: Universal



Part Number: 75013
 Carlin flange gasket 801 STD
Dimensions: 8 1/2"OD X 5 1/4"ID
Used in models: 801 STD





Part Number: 75014
 Carlin flange gasket 40246
Dimensions: 8 1/2"OD X 4 1/8"ID
Used in models: 501, 601 & 701 STD



Part Number:
 FC30-1005 (11oz. Caulk tube)
 FC30-1040 (1 gal. Pail)
 DO-ALL+ Furnace cement
Packaging: Bulk



Includes:
 1 - each of the above part numbers
 Cures in 24 hours. Rated at 3000 degrees F. Will not shrink, pull away, crack, sag, run out of joint or lose sealing properties. Not harmed by freezing and thawing
 Used in cementing & resetting furnaces, boilers, stoves, chimney collars, sealing flue pipes, cementing & bedding of fire brick, boards and combustion chambers.

Part Number: 75015
 Carlin flange gasket 40287
Dimensions: 8 1/4"OD X 4 1/8"ID
Used in models: 201 & 301 STD



Part Number: 75017
 Miller flange gasket
Dimensions: 12 13/16"L X 4 9/16"W
Used in models: MSH / Miller #: 689505



- Part Number(s):**
- FR1-10 (1" DIA. X 10' Long)
 - FR1-25 (1" DIA. X 25' Long)
 - FR1-160 (1" DIA. X 160 Long)
 - FR112-100 (1 1/2" DIA. X 100' Long)
 - FR114-100 (1 1/4" DIA. X 100' Long)
 - FR12-10 (1/2" DIA. X 10' Long)
 - FR12-25 (1/2" DIA. X 25' Long)
 - FR12-550 (1/2" DIA. X 550' Long)
 - FR14-10 (1/4" DIA. X 10' Long)
 - FR14-25 (1/4" DIA. X 25' Long)
 - FR14-2600 (1/4" DIA. X 2600' Long)
 - FR34-10 (3/4" DIA. X 10' Long)
 - FR34-25 (3/4" DIA. X 25' Long)
 - FR34-280 (3/4" DIA. X 280' Long)
 - FR38-10 (3/8" DIA. X 10' Long)
 - FR38-25 (3/8" DIA. X 25' Long)
 - FR38-1000 (3/8" DIA. X 1000' Long)
 - FR58-10 (5/8" DIA. X 10' Long)
 - FR58-25 (5/8" DIA. X 25' Long)
 - FR58-350 (5/8" DIA. X 350' Long)



Part Number: 75018
 Miller flue gasket
Dimensions: 7 1/8"OD X 5 1/8"ID
Used in models: CMF, MOC & MGC
 Miller #: 301195000



Part Number: 75019
 Miller gasket kit
Includes:
 1 - 75000 (Miller # 301205000)
 1 - 75001 (Miller # 301181000)
 1 - 75002 (Miller # 300001000)
 1 - 75018 (Miller # 301195000)
Used in models: CMF, MOC, & MGC



Part Number: 75020
 Carlin gasket kit
Includes:
 5 - 75016 Carlin #40287
 1 - 75009 (Model 1150)
 1 - 75010 (Model 1050)
 1 - 75011 (Model 801 PF)
 1 - 75012 (Model 301-701 PF)
 1 - 75013 (Model 801 STD)
 1 - 75014 (Model 501-701)
 1 - 75015 (Model 201 & 301)
Used in models: 99-101 CRD, EZ1, 1150, 1050, 801 PF, 301,501, 601, & 701 PF, 801 STD, 501, 601, & 701 STD, 201 & 301 STD.

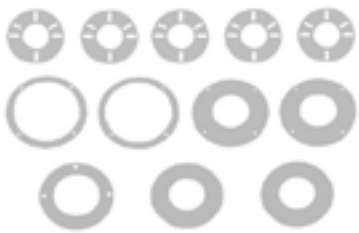

Knit braided fiberglass rope
Packaging: Boxed
Includes:
 1 - each of the above parts listed
 Our knit-braided fiberglass rope is manufactured to give superior qualities to high-temperature rope without the hazards associated with outdated materials. Flex-Rope resists temperatures up to 1000° F (538° C) Because of the special knit-braided process, it is available in a variety and densities.

Features and Benefits:
 Flex-Rope is extremely strong, resilient, and flexible. The special knit-braided process enables Flex-Rope to spring back to its original shape after compression, making it an excellent choice for gasketing that acts as a heat break or door seal. Used as gasketing for industrial ovens and furnaces, boilers and wood burning stoves. Makes an excellent core for tadpole tape gasketing.

Section 5 - Refractories & Gaskets



TROUBLE SHOOTING GUIDELINES

1. Work safely:

Always bring a fire extinguisher with you to the heater location, and always check the combustion chamber for raw fuel!. Do not fire a burner with a loaded chamber. Clean it up first. Better to be safe than sorry.

2. Talk to the customer:

Find out as much as you possibly can about the operating condition of the equipment prior to the service call. Ask if the furnace has been recently serviced, when was the last time it was cleaned, when was the last oil delivery, etc.

These types of questions can be valuable clues that may help determine why the equipment failed to operate.

3. Set the room thermostat:

Set for "HEAT," and raise the set point to its maximum setting.

4. Stick the tank:

This may seem like a waste of time (especially if the customer claims that they "just got a delivery the other day."), but it is a good habit to get into. I have wasted many hours over the years trying to get fuel units to pick up oil from empty tanks that were, "filled yesterday."

5. Now you are ready to begin working on the furnace itself:

Turn off the power switch and check the combustion chamber if you have not already done so. Clean up any raw fuel. The presence of raw fuel would be a good indication that there is oil up to the nozzle and that the problem lies somewhere in the ignition system. If the chamber is dry, feel the supply plenum (on forced air systems) or the water pipes (on boilers). In either case, they will be cold if the system has been down for any length of time. If they are hot to the touch, check to see if the equipment has shut down due to limit opening.

Likely problem areas would be an inoperative blower motor, dirty filters, or perhaps a bad circulator.

6. At this point you have been on the job site for about five minutes and may have already located the problem area:

If not, push the reset button on the primary control or stack switch. Make sure you have your fire extinguisher handy (just in case) and develop the habit of standing clear of the draft regulator and inspection port.

One of three things will happen. The burner motor will start and the burner will fire, the burner motor will start and the burner will not fire, or nothing at all happens.

7. If there is no response when pushing the reset, there is some sort of electrical problem with the equipment:

Use a voltmeter and confirm that there is voltage (usually 120 volts) to the primary control or stack switch. Disconnect the wires from the "T - T" terminals and jumper T to T on the control.

One a primary control, disconnect one of the yellow wires from the cad cell eye. Ambient light, a shorted eye, or a short in the wires from the cad cell will keep the burner from firing.

On stack controls, "step" the contacts by gently pulling and releasing the drive shaft. Try carefully jumping out the cold contacts.

Push the reset button on the burner motor, it may have tripped. At some point either the burner will fire or you will find the problem.

8. If the burner starts, but does not fire, turn it off after 10 seconds of operation:

Allowing the burner to run until the safety trips, may load the chamber with excess oil.

Disconnect the jet line (the line that connects the fuel unit to the nozzle line) from the nozzle line and direct it into a clear container.

Take enough oil (several ounces) so you can observe the sample for water or other contamination.

Install an oil pressure gauge in the nozzle line and check the pressure. On most systems the pressure should be set at 100 psi.

9. No oil at the jet line indicates some sort of delivery problem:

Check the coupling and confirm that the fuel unit drive shaft is turning.

Check vacuum. Very high vacuum indicates a restriction (or possibly a very long distance to the tank). No vacuum may indicate an air leak if the tank is below the burner.

Remove the side cover from the pump. Excessive dirt will require that the pump screen is cleaned and the pump may have to be replaced.

10. Good oil delivery at 100 psi and a clean oil sample indicates that the problem is in the oil burner itself:

Check the nozzle, the transformer, and the electrodes. The problem is somewhere in this area.

Conclusion:

These steps will allow you to work on any oil burner system with confidence. When working on any furnace, boiler, or mechanical system always look for logical procedures to follow that will allow you to quickly eliminate the unlikely areas and get right to the problem.

Reproduced by special permission of: **Oilheating Magazine.**



Part Number: KK100
 Burner coupling - KK100 kit
Packaging: Carded w/hanger knockout
Includes:
 Coupler assembled with 1/2" motor shaft end, and a 5/16" fuel unit shaft cap on the other. A 7/16" fuel unit shaft end cap is also enclosed. Over-all 5" assembled coupler length.



Part Number: KK400
 Burner coupling - Ultra KK400
Packaging: Flambeau utility box
Includes:
 The Ultra Coupling Kit provides everything the service technician needs for instant, on-the-job burner coupling repair and replacement. Packaged in a sturdy tool box. Each kit contains:
 10 - 12" length coupler shaft tubing
 24 - 1/2" end caps - grey
 16 - 5/16" end caps - green
 8 - 7/16" end caps - orange
 2 - 5/8" end caps - blue
 2 - 3/8" end caps - yellow
 1 - Torrington adapter
 1 - Handi-Kutter tool
 1 - 10 pk. repl. blades for Kutter
 1 - Instruction sheet



Part Number: KK100B-06
 Burner couplings - KK100 - Bulk 6/pk.
Packaging: Poly bagged & tagged
Includes:
 6 - KK100 Couplers assembled with 1/2" motor shaft end cap, and a 5/16" fuel unit end cap on the other. Also includes 6 - 7/16" end caps. This kit will meet most coupler replacement needs. Over-all 5" assembled coupler length.



Part Number: KK112
 Burner coupling - KK112 kit 12/pk
Packaging: Boxed in attractive carton
Includes:
 Everything needed to replace almost any defective domestic burner coupler.
 12 ea. 6" x 1" OD assembled couplers with 1/2" and 5/16" end caps. (Over-all 6" coupler length)
 4 ea. 1/2" motor end caps
 8 ea. 7/16" pump end caps
 3 ea. 5/16" pump end caps



OEM Ready Fit Couplers

- Ready to use on the most popular burners
- No cutting or fitting necessary
- Strong and lightweight
- 12 assembled couplers per box
- Unaffected by humidity
- Unaffected by oil and most chemicals
- Made in the U.S.A.
- Reliable



Our Pioneer brand OEM couplers are cut to the exact size for the below listed OEM models. A great way to save time on tune-ups and quick repairs.

Part Number	OEM Name	OEM Model
KK500B	Beckett	2454
KK500C	Carlin	201 - 301 CRD
KK500CA	Carlin	99RJE, 1020J, CRD 98-102
KK500CA-1	Carlin	1020 Mini pump
KK500W	Wayne	13279
KK500WA	Wayne	100386
KK500WM	Weil-McLain	QB180 & QB300

NOTE: Custom lengths are available to quote

Part Number: KK120
 Burner coupling - KK120 kit
Packaging: Carded w/hanger knockout
Includes:
 Coupler assembled with 1/2" motor shaft end cap on one side, and a 1/2" fuel unit shaft on the other. 5" over-all coupler length. Other end cap sizes include 5/8", 7/16", 3/8", and 5/16".





Burner Couplings - Bulk

Our coupler tubing is made of the same ridged urethane tubing used in our popular KK100 coupler kits. Great for making your own custom lengths.



Part Number	Tube OD	Tube Length
1T06	1"	6"
1T12	1"	12"
1T15	1"	15"
1T36	1"	36"

Burner Coupling End Caps

Bulk Pioneer Coupling End Caps

Our super strong plastic end caps are tough. Built to take high torque, shock starts, and stops.



Part Number	Shaft Size	Color Code
5/16	5/16	Green
3/8	3/8	Yellow
7/16	7/16	Orange
1/2	1/2	Gray
5/8	5/8	Blue

Part Number: HK
 Handi-Kutter - Pioneer coupling cutter
Packaging: Boxed in attractive carton
Includes:
 The Pioneer Handi-Kutter comes fully assembled and ready to serve all your coupler cutting needs.



Part Number: 1T06A
 Burner coupling kit - replaces WW#: S85-510
Packaging: Poly bagged & tagged
Includes:
 This coupler packaging style rivals WW kit #:99A or S85-510
 1 - 6" koupling shaft
 2 - 1/2" end caps
 2 - 7/16" end caps
 1 - 5/16" end caps



Part Number: 1T06B
 Burner coupling kit - replaces WW#: S85-520
Packaging: Poly bagged & tagged
Includes:
 This coupler packaging style rivals WW kit #:101 or S85-520
 1 - 6" koupling shaft
 2 - 1/2" end caps
 1 - 7/16" end caps
 2 - 5/16" end caps



Part Number: HKB-10
 Handi-Kutter replacement blades
Packaging: Plastic container
Includes:
 10 - stainless steel replacement blades. These blades are razor sharp, so please use caution when handling them. Blades are easy to install. Using a #2 flat screw driver remove screws holding existing blade, remove old blade, position new blade with sharp edge facing the cutting area, and secure in place with screws previously removed.



Part Number: TA
 Splined Hub-Adapters
Packaging: Bulk
Includes:
 Four designed splines within the Hub provide for sure gripping action for quick starts. Specifically designed for use with Torrington Blowers. Dimension are: 1" Hub Length, 1 1/8" Hub ID, 1 1/4" Hub OD, 11/16" L X 1/2" OD male connector 1 11/16" Over-all length



Part Number: KK100HK
 Burner coupling & Handi-Kutter kit
Packaging: Poly bagged & tagged
Includes:
 Coupler assembled with 1/2" motor shaft end, and a 5/16" fuel unit shaft cap on the other. A 7/16" fuel unit shaft end cap is also enclosed. Over-all 5" assembled coupler length. Our Handi-Kutter coupling cutter is also included.





Spring / Coiled Circulator Couplers

Part Number: 10010	
<p>Description: Spring coupler - 10010 Bore size: 1/2 X 1/2 OAL: 1 5/16" HP Range: 1/12 to 1/3 HP Rotation: CCW Fits B & G: 118705, 189110, 118723, 118705, & 189110. Fits Armstrong: 806026, 806168 & 806026.</p>	

Part Number: 10023	
<p>Description: Spring Coupling - 10023 Bore size(s): 1/2 X 1/2 or 1/2 X 5/8 OAL: 1 7/8" HP Range: 1/2 to 3/4 HP Rotation: CW Fits B & G: 118473, 118708 & 188709. Fits Armstrong: 807436 & 806137</p>	

Part Number: 10034	
<p>Description: Spring Coupling - 10034 Bore size: 5/8 X 5/8 OAL: 2 1/4" HP Range: 1 HP Rotation: CW Fits B & G: 118476 & P77271. Fits Armstrong: 812734 & 816665.</p>	

Part Number: 10045	
<p>Description: Spring Coupling - 10045 Bore Size(s): 1/2 X 1/2 or 1/2 X 5/8 or 5/8 X 5/8 OAL: 2 5/16" HP Range: 1/4 to 1 HP Rotation: CW Fits Taco: 121, 122, 131, 132, 133, & 138. Fits Woods: 3J & 4J</p>	





Part Number: 70010	
<p>Description: Spring Coupling TACO Bore Size: 1/2 X 3/8 OAL: 1 7/8" HP Range: 1/12 to 1/3 HP Rotation: CW Replaces: 110-009RP</p>	

NOTE: Rotation listed is determined by viewing the motor with the shaft pointing away. Always check rotation prior to installing. If looking at pump shaft end reverse rotation.

Section 6 - Burner & Pump Couplers

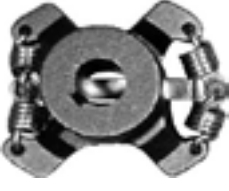

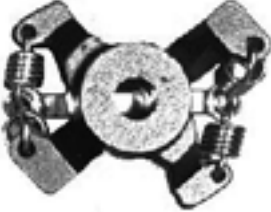
B & G / Armstrong Circulator Couplers

 41100	 41101	 41102
 41288	 41289	 *41299
<p>*Please note: We have replaced our old “zink” style coupling with our 41300 “cast iron” coupling and selling it under the old zink coupling part number of 41299. Please make note of this change.</p>		

Crown P/N	Armstrong P/N	B & G P/N	Bore Size ID	Type
41100	810120-008	186410	5/8" X 1/2"	Iron
41101	816665-000	118476	5/8" X 5/8"	Iron
41102	806168-001	118723	1/2" X 1/2"	Iron
41288	810120-006	118709	1/2" X 5/8"	Iron
41289	810120-003	118473	1/2" X 1/2"	Iron
41299	806026-001	118705	1/2" X 1/2"	Iron
41300	Now is P/N 41299.			

Part Number: 41285-12
 Hydronic circulator lube oil - Extended Spout
Packaging: Bottled and boxed
Includes:
 12 - 4 oz. bottles per case
 A fine blend of hydronic circulator oil.
 The oil contains oxidation and corrosion inhibitors
 for maximum protection. Each bottle features
 a telescoping spout when dripping oil is an issue and for dispensing
 ease in hard to reach locations.





Woods Couplers & Rubber Sleeves

The Wood's Sure-Flex® coupler can be installed quickly and easily, because there are no bolts, gaskets, covers or seals. Alignment can be checked with a straightedge placed across the outside of the precision-machined flanges. The teeth of the sleeve lock into the teeth of the flanges without clamps or screws. There is no rubbing action of metal against rubber to cause wear. Couplings are not affected by abrasives, dirt, or moisture. This eliminates the need for lubrication or maintenance, provides clean, dependable, quiet performance.



J - SERIES FLANGES

Type J flanges size 3 and 4 are manufactured of sintered carbon steel. The powdered metal manufacturing process provides high dimensional accuracy and uniform material properties for high strength. Size 5 and 6 are made of high strength cast iron.



S - SERIES FLANGES

Type S flanges are die cast of high strength cast iron and all are finished bored to size for a slip on fit on a standard shaft.



They too can be used in combination with the standard JE rubber inserts.

All flanges are bored-to-size for a slip fit on standard shafts. Type J flanges can be used with sleeves of any construction except the Hytrel. Each flange has a key seat and one (1) set screw over the keyway.

Part Number	Description
41904	WOODS COUPLER 3J X 1/2
41939	WOODS COUPLER 3J X 3/4
41905	WOODS COUPLER 3J X 5/8
41903	WOODS COUPLER 4J X 1
41906	WOODS COUPLER 4J X 1/2
41926	WOODS COUPLER 4J X 3/4
41907	WOODS COUPLER 4J X 5/8
41915	WOODS COUPLER 4J X 7/8
41918	WOODS COUPLER 5J X 1
41919	WOODS COUPLER 5J X 1 1/8
41908	WOODS COUPLER 5J X 1/2
41931	WOODS COUPLER 5J X 15/16
41917	WOODS COUPLER 5J X 3/4
41909	WOODS COUPLER 5J X 5/8
41923	WOODS COUPLER 5J X 7/8
41929	WOODS COUPLER 6J X 1
41927	WOODS COUPLER 6J X 1 1/8
41930	WOODS COUPLER 6J X 1 3/8
41935	WOODS COUPLER 6J X 15/16
41941	WOODS COUPLER 6J X 3/4
41910	WOODS COUPLER 6J X 5/8
41928	WOODS COUPLER 6J X 7/8
41940	WOODS COUPLER 10J X 1 1/4

Part Number	Description
53340	WOODS COUPLER 5S X 1/2
53341	WOODS COUPLER 5S X 5/8
53342	WOODS COUPLER 5S X 3/4
53343	WOODS COUPLER 5S X 13/16
53344	WOODS COUPLER 5S X 7/8
53345	WOODS COUPLER 5S X 15/16
53346	WOODS COUPLER 5S X 1
53347	WOODS COUPLER 5S X 1 1/16
53348	WOODS COUPLER 5S X 1 1/8
53349	WOODS COUPLER 5S X 1 3/16
53350	WOODS COUPLER 5S X 1 1/4
53351	WOODS COUPLER 6S X 5/8
53352	WOODS COUPLER 6S X 3/4
53353	WOODS COUPLER 6S X 7/8
53354	WOODS COUPLER 6S X 15/16
53355	WOODS COUPLER 6S X 1
53356	WOODS COUPLER 6S X 1 1/16
53357	WOODS COUPLER 6S X 1 1/8
53358	WOODS COUPLER 6S X 1 13/16
53359	WOODS COUPLER 6S X 1 1/4
53360	WOODS COUPLER 6S X 1 5/16
53361	WOODS COUPLER 6S X 1 3/8
53362	WOODS COUPLER 6S X 1 7/16
53363	WOODS COUPLER 6S X 1 1/2
53364	WOODS COUPLER 6S X 1 5/8
53365	WOODS COUPLER 6S X 1 3/4
53366	WOODS COUPLER 6S X 1 7/8

Section 6 - Burner & Pump Couplers



Woods Couplers & Rubber Sleeves

S - SERIES FLANGES - CONTINUED

Part Number	Description
53368	WOODS COUPLER 7S X 3/4
53369	WOODS COUPLER 7S X 7/8
53370	WOODS COUPLER 7S X 15/16
53371	WOODS COUPLER 7S X 1
53372	WOODS COUPLER 7S X 1 1/16
53373	WOODS COUPLER 7S X 1 1/8
53374	WOODS COUPLER 7S X 1 3/16
53375	WOODS COUPLER 7S X 1 1/4
53376	WOODS COUPLER 7S X 1 5/16
53377	WOODS COUPLER 7S X 1 3/8
53378	WOODS COUPLER 7S X 1 7/16
53379	WOODS COUPLER 7S X 1 1/2
53380	WOODS COUPLER 7S X 1 5/8
53381	WOODS COUPLER 7S X 1 7/8
53383	WOODS COUPLER 8S X 7/8
53384	WOODS COUPLER 8S X 15/16
53385	WOODS COUPLER 8S X 1
53386	WOODS COUPLER 8S X 1 1/16
53387	WOODS COUPLER 8S X 1 1/8
53388	WOODS COUPLER 8S X 1 3/16
53389	WOODS COUPLER 8S X 1 1/4
53390	WOODS COUPLER 8S X 1 5/16
53391	WOODS COUPLER 8S X 1 3/8
53392	WOODS COUPLER 8S X 1 7/16
53393	WOODS COUPLER 8S X 1 1/2
53394	WOODS COUPLER 8S X 1 9/16
53395	WOODS COUPLER 8S X 1 5/8
53396	WOODS COUPLER 8S X 1 11/16
53397	WOODS COUPLER 8S X 1 3/4
53398	WOODS COUPLER 8S X 1 7/8
53399	WOODS COUPLER 8S X 1 15/16
53400	WOODS COUPLER 8S X 2 1/16
53401	WOODS COUPLER 8S X 2 1/8
53402	WOODS COUPLER 8S X 2 3/8

Flexible sleeves for Wood's Sure-Flex couplings are available in four materials (EPDM, Neoprene, Hytel and Urethane) and in three basic constructions. The most common ones being listed here.

J sleeves are molded EPDM rubber (E) or Neoprene (N). They are available in one-piece solid construction (JE, JN) or one-piece split construction (JES, JNS). These sleeves may be used in any Sure-Flex flange within a given size.



JE - SERIES SLEEVES

Part Number	Description
41911	WOODS EPDM SLEEVE 3JE
41912	WOODS EPDM SLEEVE 4JE
41913	WOODS EPDM SLEEVE 5JE
41914	WOODS EPDM SLEEVE 6JE
41924	WOODS EPDM SLEEVE 7JE
41916	WOODS EPDM SLEEVE 8JE
41925	WOODS EPDM SLEEVE 9JE
41920	WOODS EPDM SLEEVE 10JE
41934	WOODS EPDM SLEEVE 11JE



JES - SERIES SLEEVES

Part Number	Description
53203	WOODS EPDM SLEEVE-SPLIT 3JES
53204	WOODS EPDM SLEEVE-SPLIT 4JES
53205	WOODS EPDM SLEEVE-SPLIT 5JES
53206	WOODS EPDM SLEEVE-SPLIT 6JES
53207	WOODS EPDM SLEEVE-SPLIT 7JES
53208	WOODS EPDM SLEEVE-SPLIT 8JES
53209	WOODS EPDM SLEEVE-SPLIT 9JES
53210	WOODS EPDM SLEEVE-SPLIT 10JES



Woods Couplers & Rubber Sleeves

These sleeves are of two-piece design with a retaining ring. They are available in EPDM (E). They may be used with any flange within a given size.



H (Hytre) sleeves, are designed for high-torque applications, transmit four times as much power as an equivalent EPDM or Neoprene sleeve.



E - SERIES SLEEVES 2 PC WITH BAND

Part Number	Description
53170	WOODS EPDM SLEEVE 4E - 2 PC
53171	WOODS EPDM SLEEVE 5E - 2 PC
53172	WOODS EPDM SLEEVE 6E - 2 PC
53173	WOODS EPDM SLEEVE 7E - 2 PC
53174	WOODS EPDM SLEEVE 8E - 2 PC
53175	WOODS EPDM SLEEVE 9E - 2 PC
53176	WOODS EPDM SLEEVE 10E - 2 PC
53177	WOODS EPDM SLEEVE 11E - 2 PC
53178	WOODS EPDM SLEEVE 12E - 2 PC
53179	WOODS EPDM SLEEVE 13E - 2 PC
53180	WOODS EPDM SLEEVE 14E - 2 PC
53181	WOODS EPDM SLEEVE 16E - 2 PC

Available in one-piece solid construction or split construction. Hytre sleeves can be used only with S, C, and SC flanges. They cannot be used with J or B flanges or as direct replacements for EPDM or Neoprene sleeves.

HS - SERIES SLEEVES - SPLIT

Part Number	Description
53211	WOODS HYTREL SLEEVE-SPLIT 6HS
53212	WOODS HYTREL SLEEVE-SPLIT 7HS
53213	WOODS HYTREL SLEEVE-SPLIT 8HS
53214	WOODS HYTREL SLEEVE-SPLIT 9HS
53215	WOODS HYTREL SLEEVE-SPLIT 10HS
53216	WOODS HYTREL SLEEVE-SPLIT 11HS
53217	WOODS HYTREL SLEEVE-SPLIT 12HS
53218	WOODS HYTREL SLEEVE-SPLIT 13HS
53219	WOODS HYTREL SLEEVE-SPLIT 14HS

JN - SERIES SLEEVES

Part Number	Description
53183	WOODS NEOPRENE SLEEVE 3JN
53184	WOODS NEOPRENE SLEEVE 4JN
53185	WOODS NEOPRENE SLEEVE 5JN
53186	WOODS NEOPRENE SLEEVE 6JN
53187	WOODS NEOPRENE SLEEVE 7JN
53188	WOODS NEOPRENE SLEEVE 8JN



H - SERIES SLEEVES

Part Number	Description
53220	WOODS HYTREL SLEEVE 6H
53221	WOODS HYTREL SLEEVE 7H
53222	WOODS HYTREL SLEEVE 8H
53223	WOODS HYTREL SLEEVE 9H
53224	WOODS HYTREL SLEEVE 10H
53225	WOODS HYTREL SLEEVE 11H
53226	WOODS HYTREL SLEEVE 12H
53227	WOODS HYTREL SLEEVE 13H
53228	WOODS HYTREL SLEEVE 14H



JNS - SERIES SLEEVES - SPLIT

Part Number	Description
53190	WOODS NEOPRENE SLEEVE 3JNS
53191	WOODS NEOPRENE SLEEVE 4JNS
53192	WOODS NEOPRENE SLEEVE 5JNS
53193	WOODS NEOPRENE SLEEVE 6JNS
53194	WOODS NEOPRENE SLEEVE 7JNS
53195	WOODS NEOPRENE SLEEVE 8JNS

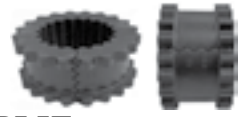

NOTE: Need a Dura-Flex or Love Joy coupling? We can get great deals on those items as well. Call for pricing. Standard lead-time is 3 working days ARO.



Manufacturer Rep Listing

Firm Name	Contact	Territory Covered
Contact Crown directly to: 1) To locate an authorized Crown dealer in your area. 2) If you are an OEM seeking parts for your ignition needs. Crown Engineering Corporation P.O. Box 846 - Farmingdale, NJ 07727 Tel#: (800) 631-2153 / Fax#: (888) 645-7278 Website: www.crownengineering.com E-mail: sales@crownengineering.com	Mr. Mike Palmer	AZ - FL -NM - NY -Long Island - NYC, NY- South of Westchester County Upstate NY (North of Westchester Cty.) NJ-North, OH-Eastern - PA-Western - NC - SC - TN - WI -Eastern - WV
ETC Sales Company P.O. Box 235 - Paoli, PA 19301 Tel#: (610)296-3527 / Fax#: (610)640-4271 E-mail address: monsgwen@msn.com	Mr. Mons King	Delaware, Eastern Pennsylvania, Maryland, Virginia, Washington D.C., & Southern New Jersey
Pilgrim Sales 7 Pilgrim Road - Marblehead, MA 01945 Tel#: (781)639-8004 / Fax#: (781)639-1157 Cell#: (617)548-2813 E-mail: deangelo@pilgrimsales.net	Mr. Lennie DeAngelo	CT - MA - ME - NH - RI -VT
R.A. Kaplan Inc. 10814 Coldwater Road - Ft. Wayne, IN 46845 Tel#: (260)637-0676 / Fax#: (260)637-2996 Website: www.rakaplaninc.com E-mail: mkaplan@rakaplaninc.com	Mr. Mark Kaplan Mr. Maark Jones Mr. Kale Ericson Mr. Dan Corwin Ms. Stacy Kaplan Ms. Linda Shank Mr. Bob Kaplan Ms. Melissa Browning	Illinois Indiana Kentucky, Michigan Wisconsin (Eastern)
Sales Engineers 12909 Pioneer Trail - Eden Prairie, MN 55347 Tel#: (612) 944-0773 / Fax#: (612) 944-1073 Website: www.salesengineersinc.com E-mail: jdungan@salesengineersinc.com	Mr. Mike Dungan Mr Jim Dungan	Minnesota, North Dakota, South Dakota & Wisconsin (Western)
TSS Associates Inc. 19 Rustyville Road - Albany, NY 12211 Tel#: (518)621-7283 / Fax#: (518)375-7039 E-mail: support@tssassociatesinc.com Website: www.tssassociatesinc.com	Ms. Brigitte Grady Mr. Steve Grady Mr. Rich Sebast Mr. Don Knuth	Upstate NY - Westchester County

Canadian Representative

Alltemp Products Co. Ltd. 827 Brock Road South Pickering, Ontario - Canada L1W-3J2 Tel#: (905) 831-3311 / Fax#: (905) 831-1864 E-mail: sales@rotom.com Website: www.alltemp.ca	Mr. Richard Chalmers	Canadian stocking distributor - All Provinces
--	----------------------	---

Worldwide Representative

Alex Bauer and Company 2429 Vauxhall Road - Union, NJ 07083 Tel#: (908) 964-4042 / Fax#: (908) 688-6668 E-mail address: export@cs123.com Website: alexbauer.com	Mr. G. R. Leiz Mrs. Leslie O'Brien	Worldwide
--	---------------------------------------	-----------

REVISED 09/28/16



Copper oil Lines - Mueller Streamline®

Our oil lines are made of genuine Mueller Streamline® dehydrated and nitrogen purged sealed copper tubing. It is of a consistent dead soft temper, bright, and thoroughly dried. A cleaning and drying process removes moisture and contaminants and is manufactured in accordance with ASTM-B-280 and ANSI-B9.1 refrigeration industry standards. We do the field work for you...we cut, add flair nuts, flair each open end, & package. We offer a variety of lengths to meet your needs!



Crown P/N	Dimension	Form
40449	3/16" Dia. x 16" Long	Straight
40450	3/16" Dia. x 5" Long	Straight
40451	3/16" Dia. x 8" Long	Straight
40452	Weil McLain Oil line	644-000-064
40453	3/16" Dia. x 20" Long	Straight
40454	3/16" Dia. x 12" Long	Straight
40455	3/16" Dia. x 16" Long	Coiled
40456	1/4" Dia. x 16" Long	Straight
40457	1/4" Dia. x 16" Long	Coiled
40458	1/4" Dia. x 12" Long	Straight
40461	1/4" Dia. x 8" Long	Straight
40463	1/4" Dia. x 5" Long	Straight
40459	3/16" x 1/4" M/F	Reducer M/F
63454	#41 - 3/16 Standard	Flare nut
63456	#41 - 1/4 Standard	Flare nut

Section 7 - Oil Handling, Gauges, & Smoke Bombs

Part Number: 40360

Miller oil line kit

Packaging: Poly bagged & tagged

Includes:

- 1 - 13494 elbow adapter
- 1 - 40459 flare reducer
- 1 - 40361B 3/16" Dia. X 7" Long oil line
- 1 - 40362B 3/16" Dia. X 11" Long oil line
- 1 - Instruction sheet

This convenient kit has everything you need to update a variety of Wayne burners, as well as, Miller mobile gun furnaces equipped with power oil burners.



Part Number: 40470

Anti-Hum Device - Silent Flow

Packaging: Individually boxed

Includes:

- 1 - Silent flow with 1/2" adaptor spring.
- For use on all domestic type pressure atomizing oil burners. Silent flow includes a 1/2" adaptor for use with 1/2" Dia. copper tubing and an easy to follow instruction sheet. Simple to install and effective in reducing oil line noise.





Part Number(s):
 41411-48 (Specs. 2 3/4" OD x 3/4" ID x 3" Long - 48/CS)
 41411-12 (Specs. 2 3/4" OD x 3/4" ID x 3" Long - 12/CS)
 41412-12 (Specs. 3 1/4" OD x 3/4" ID x 4" Long)
 41416-48 (Specs. 2 3/4" OD x 1" ID x 3 5/8" Long - 48/CS)
 41416-12 (Specs. 2 3/4" OD x 1" ID x 3 5/8" Long - 12/CS)
 Oil Filters - Rayon type for 1A-25A
Packaging: Poly bagged & corrugated carton
Includes:
 Rayon filter elements individually packaged with gaskets.
 Dash numbers indicates number of filters per carton.
 Our "CLEAN FLOW", Rayon filter is a solid one piece construction...no felt fibers, or strings to hamper the oil flow.

41411 for use in
 Autoflo F-300
 Federal A77
 General 1A-25A
 Sid Harvey XF-25/264
 Unifilter 77
 Westwood S-254



41412 for use in
 Autoflo F-400
 General 2A-700A
 Sid Harvey XF-1
 Unifilter 99
 Westwood S-252

41416 for use in
 Fulflo F-B4, AS-4, & B-4

Characteristic's

Color	White
Surface Area, in²	52
Volume, in³	12
Firing Rate, GPH	10
Clean Press. Drop	0.4
Dirt Capacity, oz.	1.4
Ending Press. Drop	10.00
Filtration Depth	Medium
Micron Range	25 to 50

Part Number:
 41420-12 (Replaces General 2A-700A)
 Oil Filters - Felt type 2A-700A
Packaging: Individually bagged with gaskets
Includes:
 12 - Individual filters with gaskets.
 Made for domestic fuel oils. Made of felt discs. This 40 micron rated filter removes impurities that might hamper the burner's operation.



Part Number: **Wool Brand Filters - Bulk**
 41421-30 (Replaces Fulflo FB-10")
 Oil Filters for Fulflo - String type
Packaging: Bulk & corrugated carton
Includes:
 30 - Individual filters **WITHOUT** gaskets.
 Made for domestic fuel oils. Made of all wool string. This 40 micron rated filter removes impurities that might hamper the burner's operation.



FB-6 & FB-8 ARE NO LONGER AVAILABLE

Part Number: **Wool Brand Filters - 6 Pk.**
 41421-06 (Replaces Fulflo FB-10")
 Oil Filters for Fulflo - String type
Packaging: Poly bagged
Includes:
 6 - Individual filters **WITHOUT** gaskets.
 Made for domestic fuel oils. Made of all wool string. This 40 micron rated filter removes impurities that might hamper the burner's operation.



FB-6 & FB-8 ARE NO LONGER AVAILABLE

Part Number (s):
 41440 (individual filter)
 41440-12 (case of 12 filters)
 Wix oil filter elements #24104
Packaging: Individually boxed
Includes:
 1 - boxed filter or
 12 - boxed filters in a master carton.
 Heating Units, Small Engines & Steam Jennies
 This spin-on filter provides effective filtration for a number of applications. The steel housing is strong and durable while the paper filter element delivers a clean supply of fuel for faultless combustion.
 UL Recognized strainer for #2 oil or lighter.



- Specifications:**
- Dimensions 4 1/2" Hgt. X 2 5/8" OD
 - Maximum flow rate is 6 GPH
 - Compact design
 - Micron rating is 10

10 MICRON





Part Number(s):
 41415-48 (Case of 48 filters with gaskets)
 41415-12 (Economy case of 12 filters with gaskets)
 Oil Filters - String type for FB-4
Packaging: Bagged w/gasket in corrugated carton
Includes:
 48 or 12 - Individual filters with gaskets.
 Made for domestic fuel oils. Made of all wool string. This 40 micron rated filter removes impurities that might hamper the burner's operation. Replaces FB-4 elements.



Part Number(s):
 41439 (Complete UL listed filter system - Individually Pkg.)
 41439-06 (Complete UL listed filter system - 6 Pack)
 Oil Filters UL - Quick Spin III
Packaging: Individually boxed
Includes:
 1 - Individually boxed filter system or
 1 - 6 pack of boxed filter system.
 Our newly designed Quick Spin III™ filtration system is now better than ever! It's the filter style of the future with our new triple leak protection shell that is tin plated carbon steel, epoxy coated, and an internal plastic base to prevent rust-out bottoms that other comparable filters are prone to.
 As always our triple leak protection filter head is made of casted aluminum and incorporates a post gasket seal, a ridged rim that grips the seal gasket, and an outter lip that encloses the entire unit...safety first! And don't forget the practical benefits like a flat bottom, so your can doesn't spill oil all around the floor.
 Our wholesale distributor's like the flat bottom design because they stack easily and our kit variety means they can offer a wider range of filtering combinations to meet their customers needs.
 To top it off our Quck Spin III™ filtration system is UL listed for use in the USA and Canada with superior 10 micron filtration that effectively removes rust, scale, and other microscopic impurities that might hamper burner operation.

Filter Characteristic's for 41439
 Canister type.....Carbon steel, tin plated & epoxy coated
 Melting point.....1100°F
 Certification.....UL & CUL Listed
 Micron Rating.....10
 Dimensions.....4 5/8" H x 3 7/16" DIA
 Rated flow rate.....25 USgph
 Filtering area.....550 square inches
 Rated work psi.....12 P.S.I.
 Filtering media.....Resin treated cellulose
 Rated work temp.....Up to 140°F
 Max. working psi.....35 P.S.I.

UL file number.....MH 25548
 UL Style.....41439

Our 41439 Filter Replaces or fits:

- Crown:** Quick-Spin I & II
- Garber:** 11V-R
- Mitco:** 290M and 264-91M
- Nozzle Guard:** NG-3300-G
- Sid Harvey:** 290-6 and 264-91
- Westwood:** F100-10
- Wix:** 24100



Part Number(s):
 41436 (Individually boxed element w/gasket)
 41436-06 (6 pack of individually boxed element w/gasket)
 Oil Filter - QS III element only
Packaging: Individually boxed w/gasket & 6/pack ctn.
Includes:
 1 - Individually boxed filter element with gasket or
 6 - Individual boxed filter elementd with gasket in carton
 Designed for superior filtration, 10 micron!
 Our Quick Spin III™ replaces Gar-Ber's® R cartridge and mounts on existing Gar-Ber® heads, or you can use our own (see part number 41437).

UL listed for use in USA and Canada



UL file: MH25548
 UL Style: 41439



UL file: MH25548
 UL Style: 80000850

Section 7 - Oil Handling, Gauges, & Smoke Bombs



Part Number: 41436K
 Oil Filter UL - Quick Spin III - Complete kit #1

Packaging: Individually boxed

Includes:

- 1 - Filter element
- 1 - Mounting head
- 1 - Mounting bracket with hardware
- 1 - Vacuum gauge 0 - 30 hg, 1/8" NPT



 UL file: MH25548
 UL Style: 41439

Part Number: 41439-06

Oil Filter - QS III element with head

Packaging: Individually boxed in carton

Includes:

6 - filter elements with 6 head mounts & post gaskets
 Effectively removes rust, scale and other microscopic impurities that might hamper the burner's operation.



X 6

 UL file: MH25548
 UL Style: 41439

Part Number: 41436G

Oil Filter UL - Quick Spin III - kit #2

Packaging: Individually boxed

Includes:

- 1 - Filter element
- 1 - Mounting head
- 1 - Vacuum gauge 0 - 30 hg, 1/8" NPT



 UL file: MH25548
 UL Style: 41439

Part Number: 41436M

Oil Filter UL - Quick Spin III - kit #3

Packaging: Individually boxed

Includes:

- 1 - Filter element
- 1 - Mounting head
- 1 - Mounting bracket with hardware



 UL file: MH25548
 UL Style: 41439

Part Number: 41403

Filter mounting bracket

Packaging: Individually bagged & tagged

Includes:

1 - mounting bracket with hardware.
 Our steel zinc plated bracket will stand up to a variety of hostile environments and vibrations.



Part Number: 41437

Filter mounting head for QS III

Packaging: Individually bagged & tagged

Includes:

1 - filter head mount - with plugged gauge port.
 The "Quick Spin III™" head mount is made of casted aluminum. The head includes two 3/8" NPT, inlet & outlet ports and a 1/8" NPT gauge port, loc-tight sealed and plugged (vacuum gauge not included).



Part Number: 41431

Filter adaptor kit for QS III

Packaging: Individually bagged & tagged

Includes:

1 - adaptor kit mounting rod with gaskets.
 Our adaptor kit allows you to mount our Quick-Spin III™ filter onto General 1A25A & 264 heads for easy modification and adaptation without welding. Use existing heads for maximum filtration with just a couple twists of the wrench. A great way to improve filtration without extra effort.





Part Number (s):

- 41402 - Vacuum gauge (0 to -30" Hg. - 1/8" NPT)
- 41402C - Vacuum gauge (0 to -30" Hg. - 1/8" NPT - Color)
- 41406 - Vacuum gauge (0 to -30" Hg. - 1/4" NPT)

Packaging: Individually Boxed

Includes:

1 - vacuum gauge boxed from the above list.
 Our vacuum gauges features a easy to read 2" face, is made of high impact acrylic bezel, with a 1/8" or 1/4" NPT bottom mount. Can be used in a variety of applications.



41402



41402C



41406

Part Number (s):

- 41404 - Pressure gauge (0 to 30 PSI - 1/8" NPT)
- 41405 - Pressure gauge (0 to 300 PSI - 1/4" NPT)
- 41452 - Pressure gauge (0 to 30 PSI - 1/4" NPT)
- 41456 - Pressure gauge (0 to 200 PSI - 1/8" NPT)
- 41457 - Pressure gauge (0 to 300 PSI - 1/8" NPT)
- 41466 - Pressure gauge (0 to 60 PSI - 1/8" NPT - 1 1/2" FACE)

Packaging: Individually Boxed

Includes:

1 - pressure gauge boxed from the above list.
 Our pressure gauges features a easy to read 2" face, is made of high impact acrylic bezel, with a 1/8" or 1/4" NPT bottom mount. Can be used in a variety of applications.



41404



41405



41452



41456



41457



BACK MOUNT
41466

Part Number (s):

- 41460 - Tridicator gauge (2.48" Long Stem X 2 1/2" Dial)
- 41461 - Tridicator gauge (2.75" Long Stem X 4" Dial)
- 41462 - Tridicator gauge (3.62" Long Stem X 2 1/2" Dial)

Packaging: Individually Boxed

Includes:

1 - tridicator gauge from the above list.
 Easy to read 2 1/2" face, made of drawn steel with corrosion resistant paint, center back mounting and a high impact polycarbonate window with chrome plated steel ring, with a 1/4"-18 NPT thread. Dual temperature ratings are: 70° F to 320° F / 20° C to 160° C and the pressure range is 0 to 200 PSI. It can be used in a variety of applications.



41460 & 41462



41461

Part Number: 41463

Thermometer with spud well

Packaging: Individually Boxed

Includes:

1 - Thermometer individually boxed.
 Easy to read 2 1/2" face, is made of drawn steel with corrosion resistant paint, center back mounting and a high impact polycarbonate window with chrome plated steel ring, with a 1/2" NPT removable brass well (2" long from back plate of gauge). Dual temperature ratings are: 32° F to 248° F and 0° C to 120° C. It can be used in a variety of applications.



Part Number: 41464

Pressure gauge for Steam

Packaging: Individually Boxed

Includes:

1 - Thermometer individually boxed.
 Easy to read 8 1/2" glass face, 1/4" NPT bottom mount in a steel case. 0-30 psi an industry standard. It can be used in a variety of steam applications.



Section 7 - Oil Handling, Gauges, & Smoke Bombs



Part Number (s):

41473 - Compound Gauge - Color Coded
 Compound gauge - Color coded

Packaging: Individually Boxed

Includes:

1 - compound gauge boxed.

Our compound Hg / PSI gauge is color coded for easy viewing and features an easy to read 2" face, is made of high impact acrylic bezel, with a 1/8" NPT, bottom mount. Can be used in a variety of applications. Senses Hg. Vacuum from 0 to 30 Hg and pressure from 0 to 30 PSI. It works great in applications where back pressure is present. Or if your not sure if there is back pressure. Don't take a chance on traditional Hg./Vac gauges. This little investment can save you lots of headache time. Stock up today!



Part Number: 43030

Tank gauge - Rope type

Packaging: Individually boxed

Includes:

1 - Tank gauge

Our tank gauge is designed in Germany and can be used in 44" oval tanks with at least one 1 1/2" diameter bushing. The cord is impervious to oil and durable. This gauge features an easy to read 2 1/2" face and extra large easy to read number and letters. an be adapted to use in 2" bushing with adaptor. (not included).



Part Number: 43031

Tank gauge - Rope type

Packaging: Individually boxed

Includes:

1 - Tank gauge

Our economy tank gauge is used in 42" & 24" tanks with face plate change & 2" BPS mounting thread. The cord is impervious to oil and durable.



TUV Tested Flow Control® de-aerator

Part Number: 43000 - TUV Tested Flow Control®

De-aerator - Flow Control®

Packaging: Individually boxed

Includes:

1 - Flow Control® de-aerator & hardware

1 - Installation instructions

Flow Control® is a unique product that allows for the safest possible transport of oil between the oil tank and the oil burner.

Incorporating the advantages of the two pipe system in only one oil line. Prevent break-downs before they occur due to air, dirt, and nozzle clogging. This product works!

TUV IMPROVED!

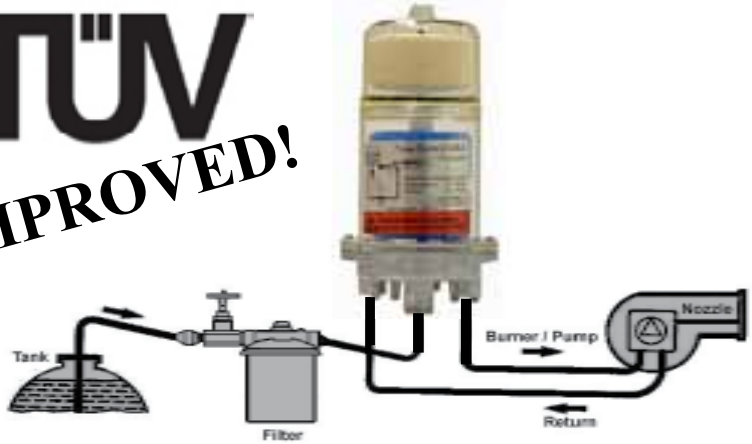

Look at all the advantages

- ♦ Fewer breakdowns
- ♦ No return line leakage
- ♦ Less soot build-up
- ♦ Simpler and cheaper installations
- ♦ Cleaner exhaust gases
- ♦ Smaller pipe dimensions
- ♦ Lower oil consumption
- ♦ Easier trouble spotting
- ♦ More burners on one suction line
- ♦ Fewer problems with suction leakage and long oil lines
- ♦ Pre-heated oil

Technical Data:

Max. nozzle capacity: 18.5 GPH
Separating capacity: Up to 4 l/h
Operating suction pressure: 7.5 psi max.
Pump connections: 1/4" NPT inner thread

Max. return oil pumped: 37 GPH
Max. ambient temp.: 140°F (60°C)
Operating over pressure: 10 psi max.
Tank connection: 1/4" NPT inner thread

Max. oil flow: 50 GPH
Max. operating temp.: 140°F (60°C)
Pressure test of pipe system: 85 psi max.
Dimensions: 3.74" X 3.74" X 5.73"



Part Number: 43003
 Fusible Valve - 3/8 (F)NPT X 1/4 (M)NPT
Packaging: Poly bagged & tagged
Includes:
 1 - Firomatic® Fusible Valve Designed to automatically close when acted upon by heat of 165° F, manufactured primarily for oil burner installations. This valve has been designed with the fusible element in the handwheel, simply replace the low cost handwheel to reset and restore the valve, eliminating the need to replace the valve. These valves can be operated manually and are provided with self-adjusting stuffing box and back seat features, which prevents leaks at the valve stem.



3/8" (F) NPT 1/4" (m) NPT

Part Number:
 43005 - 24" L x 1/2" Flexible Hose
 43006 - 36" L x 1/2" Flexible Hose
 Oil lines - Flexible Steel Braided Hose
Packaging: Poly bagged & tagged
Includes:
 1 - Flexible hose from above list with 1 adaptor fittings
 These hoses have a 1/4" NPT fittings on both ends, for expediting the installation of the Tigerloop® or Flow Control® de-aerator. Made from Perbunan rubber (inside), which is impervious to oil, water and air. This product has a diversity of uses.

Extra adaptors are available, our P/N: 43009

Specifications

- Pressure rating: 143 psi
- Max. Operating Temp: 165° F
- Max. Flow Rate: 20 GPH
- Suction: 6 Bar



NOTE: Fits or replaces Buderus #108902

Part Number:
 43019 - 24" L x 1/2" Flexible Hose
 43020 - 36" L x 1/2" Flexible Hose
 Oil lines - Flexible Steel Braided Hose
Packaging: Poly bagged & tagged
Includes:
 1 - Flexible hose from above list
 We are proud to introduce our new 36" long galvanized blue braided hose.
This hose features:
 (2) 3/8" female flare swivel ends to accommodate swinging door burner installations and hose replacement.
 -No more hose twisting!
 -Inside flare ensures a snug fit.
 -Swivel ends make installation simple.
 -Tested by the manufacturer to meet industry standards.



Part Number:
 43021 - 36" L x 1/2" Bio-fuel flexible hose
 Oil lines - Flexible Steel Braided Hose
Packaging: Poly bagged & tagged
Includes:
 1 - Flexible hose from above list with 1 adaptor fittings
 These hoses have a 1/4" NPT fittings on both ends, for expediting the installation of the Tigerloop® or Flow Control® de-aerator. This oil- and fuel-resistant flexible elastomer hose is fitted with galvanized steel wire braiding as a pressure or strength bearer. The polymer basis of the inner core is HNBR (hydrogenated butadiene acrylnitrile rubber) which is highly resistant to high temperature. Suitable for use with biodiesel. This product has a B100 Bio-fuel rating. Look for the "Green Colored" braid.

Extra adaptors are available, our P/N: 43009

Specifications

- Pressure rating: 143 psi
- Max. Operating Temp: 165° F
- Max. Flow Rate: 20 GPH
- Suction: 6 Bar



NOTE: Fits or replaces Buderus #108902

Section 7 - Oil Handling, Gauges, & Smoke Bombs



Part Number:

43022 - 24" L x 1/2" Flexible Hose
 43023 - 36" L x 1/2" Flexible Hose
 Oil lines - Flexible Steel Braided Hose

Packaging: Poly bagged & tagged

Includes:

1 - Riello™ Flexible hose from above list
 These hoses have a 1/4" (m)NPT removable fittings on one end, swivel fitting and a Riello British male thread on the other end. It's a "one, two punch" equates to easy installation and maintenance of Riello burners. The swivel really speeds up the installation process. Made from Perbunan rubber (inside), which is impervious to oil, water and air.

**NEW - NEW - NEW
 RIELLO HOSE**

Specifications

Pressure rating: 143 psi
 Max. Operating Temp: 165° F
 Max. Flow Rate: 20 GPH
 Suction: 6 Bar



BRITISH THD'S.

Part Number: 45673

Pump strainers - Model "A & B"

Packaging: Individually boxed with gasket

Includes:

Strainer and matching gasket as specified above. Made of stainless steel mesh, attached to sturdy nylon ends for long lasting support. Our ribbed design insures maximum filtration. Used in Suntec models A & B pumps. Suntec part #: 3715744 - (1 5/8" tall).



Part Number: 45674

Pump strainers - Model "J,H,S,"

Packaging: Pkg. of 4 strainers with gaskets

Includes:

4 - Strainers and 4 - Strainer gaskets
 Made of stainless steel mesh, attached to sturdy nylon ends for long lasting support. Our ribbed design insures maximum filtration. Used in Suntec models J and H pumps. Suntec part #: 131622 - (2 1/8" tall).



Part Number: 45675

Pump strainers - Model "A"

Packaging: Pkg. of 4 strainers with gaskets

Includes:

4 - Strainers and 4 - Strainer gaskets
 Made of stainless steel mesh, attached to sturdy nylon ends for long lasting support. Our ribbed design insures maximum filtration. Used in Suntec model A70 pumps. Suntec part #: 3715101 - (1 1/8" tall).



Part Number: 45676

Pump strainers - Model "J,H,S,"

Packaging: Individually boxed with gasket

Includes:

Strainer and matching gasket as specified above. Made of stainless steel mesh, attached to sturdy nylon ends for long lasting support. Our ribbed design insures maximum filtration. Suntec part #: 131622 - (2 1/8" tall).



Part Number: 45677

Pump strainers - Model "B"

Packaging: Individually boxed with gasket

Includes:

Strainer and matching gasket as specified above. Made of stainless steel mesh, attached to sturdy nylon ends for long lasting support. Our ribbed design insures maximum filtration. Used in Suntec models A pumps. Suntec part #: 3715171 - (1 3/8" tall).



Part Number: 45678

Pump strainers - Model "A"

Packaging: Individually boxed with gasket

Includes:

Strainer and matching gasket as specified above. Made of stainless steel mesh, attached to sturdy nylon ends for long lasting support. Our ribbed design insures maximum filtration. Used in Suntec model A70 pumps. Suntec part #: 3715101 (1 1/8" tall).





Part Number: 45678-50
 Pump strainers - Model "A"
Packaging: 50 Boxes per case
Includes:
 50 individually boxed strainers with gaskets packed in a master carton.
 Don't get caught short handed. Buy'em by the case!
 Made of stainless steel mesh, attached to sturdy nylon ends for long lasting support. Our ribbed design insures maximum filtration. Used in Suntec model A70 pumps. Suntec part #: 3715101 - (1 1/8" tall).



Part Number: 45685
 Pump strainer kit - B2GA
Packaging: Individually boxed with gasket
Includes:
 Strainer and matching gasket as specified above. Made of stainless steel mesh, attached to sturdy nylon ends for long lasting support. Our ribbed design insures maximum filtration. Used in Suntec model B2GA-8852
 Replaces Suntec part #: 3715746 (2 1/16" tall).



NEW!

Part Number: 45681
 Pump strainer - Riello™
Packaging: Individually boxed w/O-ring gasket
Includes:
 1 ea. Strainer and 1 ea. matching O-ring gasket. Made of stainless steel mesh, attached to sturdy nylon ends for long lasting support. Gasket is impervious to oil. Used on models F3 to F20 and R35. Riello part #: 3005719



Part Number: 45686
 Pump strainer - Model "K"
Packaging: Individually bagged with gasket
Includes:
 Strainer and matching gasket as specified above. Made of stainless steel mesh, attached to sturdy nylon ends for long lasting support. Our ribbed design insures maximum filtration. Used in Suntec model "K" pumps (not for gear set with 6 screws)
 Replaces Suntec part #: 131066.



NEW!

NOTE: Riello optional pump cover gasket is available
 Ask for P/N: 60682 sold in 10 - 25 - 100 pks.

Part Number: 45683
 Pump strainer - Danfoss kit
Packaging: Individually boxed with o-ring
Includes:
 Strainer and o-ring gasket as specified above. Made of stainless steel mesh, attached to sturdy nylon ends for long lasting support. Our ribbed design insures maximum filtration. Used in Danfoss models BFP pumps. 2 bolt cover.
 Replaces P/N: 071N1392
 NOTE: Also fits the Beckett Clean Cut Pump.



NEW!

Part Number: 45687
 Pump strainer - Levitt R3
Packaging: Individually boxed with gasket
Includes:
 Strainer and o-ring gasket as specified above. Made of stainless steel mesh, attached to sturdy nylon ends for long lasting support. Our ribbed design insures maximum filtration. Used in Suntec Levitt R-3 pumps.



NEW!

Part Number: 45684
 Pump strainer kit - B2TA
Packaging: Individually boxed with gasket
Includes:
 Strainer and matching gasket as specified above. Made of stainless steel mesh, attached to sturdy nylon ends for long lasting support. Our ribbed design insures maximum filtration. Used in Suntec model B2TA-8851
 Replaces Suntec part #: 3715742 (1 5/8" tall).



NEW!

Part Number: 45688
 Pump strainer - Danfoss CFP
Packaging: Individually boxed with gasket
Includes:
 Strainer and o-ring gasket as specified above. Made of stainless steel mesh, attached to sturdy nylon ends for long lasting support. Our ribbed design insures maximum filtration. Used in Danfoss models CFP pumps. 4 bolt cover.
 Replaces P/N: 071H0015



NEW!

Section 7 - Oil Handling, Gauges, & Smoke Bombs



Part Number(s):

60676-10
 60676-50
 60676-100
 Pump strainer gaskets - Model "J,H,S"



Packaging: Poly bagged & tagged

Includes:

A variety of packaging schemes: 10pk., 50pk or 100pk. of Strainer gaskets in a poly bag.

Our gaskets are impervious to oil, and insure a tight seal.

Used in Suntec models J and H pumps.

Suntec part #: 110441

Part Number:

60683-10 (10 pk. of O-rings)
 60683-50 (50 pk. of O-rings)
 60683-100 (100 pk. of O-rings)
 Pump strainer gaskets - Danfoss™ O-Ring



Packaging: Poly bagged & tagged

Includes:

1 Pack of either 10, 50, or 100 pcs. of above O-ring or gasket. conveniently packaged in re-sealable zip lock bags.

Our gaskets are impervious to oil and will ensure a tight seal on all your Danfoss BFP pump tune-ups.

Replaces #633B0090

Part Number(s):

60678-10
 60678-50
 60678-100
 Pump strainer gaskets - Model "A"



Packaging: Poly bagged & tagged .

Includes:

A variety of packaging schemes: 10pk., 50pk or 100pk. of Strainer gaskets in a poly bag. Our gaskets are impervious to oil, and insure a tight seal. Used in Suntec model A pumps.

Suntec part #: 3779801

Part Number:

60684-10 (10 pk. of O-rings)
 60684-50 (50 pk. of O-rings)
 60684-100 (100 pk. of O-rings)
 Pump strainer o-ring - Danfoss™



Packaging: Poly bagged & tagged

Includes:

1 Pack of either 10, 50, or 100 pcs. of above O-ring or gasket. conveniently packaged in re-sealable zip lock bags.

Our gaskets are impervious to oil and will ensure a tight seal on all your Danfoss CFP pump tune-ups.

Replaces #071H0015

Part Number:

60681-10 (10 pk. of O-rings)
 60681-50 (50 pk. of O-rings)
 60681-100 (100 pk. of O-rings)
 60682-10 (10 pk. of optional cover gaskets)
 60682-50 (50 pk. of optional cover gaskets)
 60682-100 (100 pk. of optional cover gaskets)
 Pump strainer O-Ring & Optional pump cover gasket for Riello™

Packaging: Poly bagged & tagged

Includes:

1 Pack of either 10, 50, or 100 pcs. of above O-ring or gasket. conveniently packaged in re-sealable zip lock bags.

Both gaskets are impervious to oil and will ensure a tight seal on all your Riello tune-ups.

FOR RIELLO MODELS F3 THRU F20 & R35

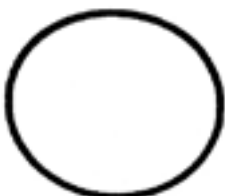

60681



60682

Part Number:

60685-10
 60685-50
 60685-100
 Pump strainer gasket - OLD Model "A"

Packaging: Poly bagged & tagged

Includes:

1 Pack of either 10, 50, or 100 pcs. of above gasket. conveniently packaged in re-sealable zip lock bags.

Our gaskets are impervious to oil and will ensure a tight seal on all your Suntec pump tune-ups.

Replaces #3779051





Part Number: 61411

Filter gasket kit for Fulflo & C4

Packaging: Poly bagged & tagged

Includes:

1 Package containing one of each of the following:

1 each Head gasket

1 each Bolt gasket

1 each Vent gasket



Part Number: 61414

Filter gasket - Vent gasket only for Fulflo & C4

Packaging: Poly bagged & tagged

Includes:

1 Package containing your specified quantity of:

1 each Vent gasket



Part Number: 61412

Filter gasket - Bolt gasket only for Fulflo & C4

Packaging: Poly bagged & tagged

Includes:

1 Package containing your specified quantity of:

1 each Bolt gasket



Part Number: 61416

Filter gasket kit for Fulflo & C4

Packaging: Poly bagged & tagged

Includes:

1 Package containing your specified quantity of:

1 each Head gasket





Part Number (s):

OSVA38 - 3/8" Oil Safety Valve
 OSVA50 - 1/2" Oil Safety Valve
 Oil safety valves - Webster® Standard

Packaging: Individually boxed

Includes:

1 - Webster® oil safety valve from above list
 The Webster® oil safety valve is ideal for use in oil supply systems which have from zero to 60 psi supply line pressure on the inlet side of the valve, but requires a sustained vacuum on the outlet side of the valve for the fuel to flow to the burner pump. This unit is UL Listed for #2 fuel oil or lighter at 60 psi maximum inlet pressure.



Look at all the advantages:

- Relieves pressure strain on fuel pump inlets*
- Prevents siphoning of fuel tanks*
- Prevents spilling due to accidental line breakage*
- Use OSVA38 for 3/8" pipe & ports 3/8 - 18 NPTF
- Use OSVA50 for 1/2" pipe & ports 1/2 - 14 NPTF

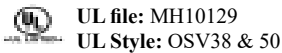

BIO VERSION

Part Number (s):

OSVA38BIO - 3/8" Oil Safety Valve
 OSVA50BIO - 1/2" Oil Safety Valve
 Oil safety valves - Webster® Bio

Packaging: Individually boxed

Includes:

1 - Webster® oil safety valve from above list
 The Webster® oil safety valve is ideal for use in oil supply systems which have from zero to 60 psi supply line pressure on the inlet side of the valve, but requires a sustained vacuum on the outlet side of the valve for the fuel to flow to the burner pump. This unit is UL Listed for #2 fuel oil or lighter at 60 psi maximum inlet pressure.



NEW!

Look at all the advantages:

- Relieves pressure strain on fuel pump inlets*
- Prevents siphoning of fuel tanks*
- Prevents spilling due to accidental line breakage*
- Use OSVA38 for 3/8" pipe & ports 3/8 - 18 NPTF
- Use OSVA50 for 1/2" pipe & ports 1/2 - 14 NPTF

Part Number (s):

- 141TF** - 1/2" NPT(m) X 3/8" NPT(m) TANK VALVE
 - B100CV** - NO LONGER AVAILABLE USE B100HCV
 - B100HCV** - 3/8" NPT(f) CHECK VALVE W/SOFT SEAL
 - B100L** - 3/8" NPT(f) LEVER VALVE
 - B104CF** - 3/8" FLARE X 1/4" NPT(m) X 1 5/8" LONG SHANK ANGLE VALVE
 - B104CFXL** - 3/8" FLARE X 1/4"NPT(m) X 2" LONG SHANK ANGLE VALVE
 - B105HCV** - 3/8" FLARE CHECK VALVE W/SOFT SEAL
 - B105F** - 3/8" FLARE VALVE
 - B200F** - 1/2" NPT(f) VALVE
 - B200HCV** - 1/2" NPT(f) CHECK VALVE W/SOFT SEAL
 - B200L** - 1/2" NPT(f) LEVER VALVE
 - B204CF** - 1/2" FLARE X 1/4" NPT(m) X 1 5/8" LONG SHANK ANGLE VALVE
 - B205APF** - 1/2" FLARE ALL PURPOSE / ANTI-HUM VALVE
 - B205F** - 1/2" FLARE VALVE
 - B205HCV** - 1/2" FLARE CHECK VALVE W/SOFT SEAL
 - B300F** - 3/4" NPT(f) VALVE
 - B400F** - 1" NPT(f) VALVE
 - HW165** - 165° F REPLACEMENT HAND WHEEL - "SILVER"
 - HW200** - 200° F REPLACEMENT HAND WHEEL - "COPPER"
 - TS150B** - THERMAL SWITCH UL ROUND JUNCTION BOX
 - TS300B** - THERMAL SWITCH UL SQUARE JUNCTION BOX
- Fusible valves

Packaging: Poly bagged & tagged

Includes:

1 - Fusible Valve, Tank Valve & Check Valve from above list
 Designed to automatically close when acted upon by heat of 165°F, unless otherwise specified. These valves has been designed with the fusible element in the handwheel, simply replace the low cost handwheel to reset and restore the valve, eliminating the need to replace the valve. These valves can be operated manually and are provided with self-adjusting stuffing box and back seat features, which prevent leaks at the valve stem. Valve bodies are made of machined brass or cast brass to reduce the erosion caused by fuel oil. The other internal parts are designed for long life and dependability. The best in it's class! All the fusible valves up to 1/2" NPT are UL listed in the US & Canada!



See Photos on next page



UL file: MH4681
 UL Style: Series 50, 100,
 & 200 Firematic valves.



UL listed for use in USA and Canada

Section 7 - Oil Handling, Gauges, & Smoke Bombs

Fusible Inline Burner Valves & Fire Safety Valves

 141TF 1/2" NPT(m) X 3/8" NPT(m) TANK VALVE - BZ	 B100CV 3/8" NPT(f) CHECK VALVE - BR	 B100F 3/8" NPT(f) VALVE - BR	 B100HCV 3/8" NPT(f) CHECK VALVE - BR
 B100L 3/8" NPT(f) LEVER VALVE - BR	 B104CF 3/8" FLARE X 1/4" NPT(m) X 1 1/4" L ANGLE VALVE - BR	 B104CFXL 3/8" FLARE X 1/4" NPT(m) X 2" L ANGLE VALVE - BR	 B105HCV 3/8" FLARE CHECK VALVE - BR
 B105F 3/8" FLARE VALVE - BR	 B200F 1/2" NPT(f) VALVE - BR	 B200HCV 1/2" NPT(f) CHECK VALVE - BR	 B200L 1/2" NPT(f) LEVER VALVE - BR
 B204CF 1/2" NPT(f) X 1/4" NPT(m) X 1 5/8" L ANGLE VALVE - BR	 B205APF 1/2" FLARE ALL PURPOSE - ANTI-HUM VALVE	 B205F 1/2" FLARE VALVE - BR	 B205HCV 1/2" NPT(f) CHECK VALVE - BR
 B300F 3/4" NPT(F) VALVE - BR	 B400F 1" NPT(F) VALVE - BR	 HW165 165° REPLACEMENT HAND WHEEL - SILVER	 HW200 200° REPLACEMENT HAND WHEEL - COPPER
 TS150B THERMAL SWITCH UL ROUND JB 3 1/4" & 4" ROUND JUNCTION BOX	 TS300B THERMAL SWITCH UL SQUARE JB 4" SQUARE JUNCTION BOX		



Part Number: 1002FD
 Valker® Fast Drying De-greaser



Packaging: Corrugated carton - sold in case lots only.
Includes:

12 - 14 oz. aerosol cans per case.
 This dielectric, non-flammable solvent is fast drying, and ideal for de-greasing small mechanical parts, fans, electric motors, and equipment. Removes grease and oil from hard to reach places. It can even be used as a spot remover.

Part Number(s):
 41900 - 1/2 Minute smoke candle - 12/pk. - 4,000 cu. ft.
 41901 - 1 Minute smoke candle - 12/pk. - 8,000 cu. ft.
 41902 - 3 Minute smoke candle - 12/pk. - 40,000 cu. ft.
 Smoke Candles - Superior

Packaging: Poly-bag
Includes:
 1 - 12/pk. and 5/pk., of each from above list.
 Our Superior smoke detectors generate smoke by chemical reaction to pinpoint leaks in heating and air conditioning duct work. Smoke varies in color from white to gray depending upon density and lighting.
 Now featuring new quantity packaging! Now available in packages of 5 for the 1/2 minute, 1 minute and 3 minute sizes.

Part Number: 2001CF
 Valker® Chem Flush - 1



Packaging: Corrugated carton - sold in case lots only.
Includes:

12 - 14 oz. aerosol cans per case.
 Chem-Flush - 1 opens fuel lines that are plugged due to ice and sludge build-up. Chem flush - 1 can also be use to clean the filter pump and nozzle strainer when used as a full maintenance or tune-up product. Therefore, greatly reducing the number of service calls due to plugged fuel lines during the heating season.



-WARNING-
 STORE IN A COOL / DRY PLACE -
 DO NOT RE-PACKAGE

Part Number: 2007CV
 Valker® Chem Flush Valve



Packaging: Bulk - sold per each.
Includes:

1 - Chem flush valve.
 The Chem-Flush - 1 valve is required when using Chem-Flush - 1 aerosol P/N: 2001CF. The valve consists of a dispensing cap, flow sight tube, pressure gauge, pressure relief valve with a threaded portion for easy adaption of a standard CO² gun.

Part Number: 41950
 Smoke test paper



Packaging: Poly bagged & tagged
Includes: 1 package of 50 strips
 Smoke test paper for Bach & Dwyer testers
 Packed in a re-sealable zip lock bag with a generous supply of 50 strips per package.

Part Number: 2008CT
 Valker® Sight tube with cap



Packaging: Poly bagged & tagged
Includes:

1 - Replacement sight tube
 This replacement sight tube is used in the Chem-Flush valve.
 They are sold per each.

Part Number(s):
 S102 - 45 Second smoke emitter 10/pk. - 150 cu. ft.
 S103 - 90 Second smoke emitter 10/pk. - 600 cu. ft.
 S104 - 150 Second smoke emitter 5/pk. - 1100 cu. ft.
 S105 - 240 Second smoke emitter 5/pk. - 2500 cu. ft.
 Smoke Emitters - Regin

Packaging: Various
Includes:
 1 - Pkg. from the above list
 Our smoke emitters generate smoke by chemical reaction. Reveals leaks and other faults in heating and air conditioning duct work. Unique plastic cartridge makes for easy handling and disposal.





Part Number(s):

- 12-7300 (Large rectangular)
- 12-7400 (Large round)
- 12-7500 (Small rectangular)
- Telescoping inspection mirrors

Packaging: Poly bagged & tagged

Includes:

1 - Mirror from above selection with extension handle.

Ideal for inspecting burner flame and inside chamber liners. Features three section telescoping action. 29-31" maximum extension. Swivel joint permits viewing from any angle. Mirror is made of highly polished stainless steel for maximum strength.

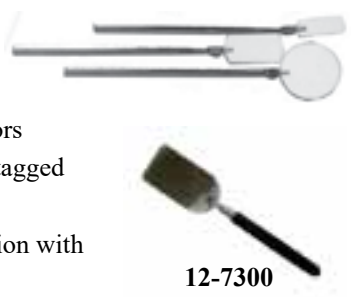

12-7300

Caution: Mirror should not be held directly in path of flame. Safety first!

Part Number: 12-EL26

Telescoping pocket lighter

Packaging: Poly bagged & tagged

Includes:

1 - Telescoping lighter tool.

Safety first!. Whether a gas or oil manual ignition test don't get caught without one of these. Light furnaces of all kinds from a safe and comfortable distance. Our lighter extends to 26", for burn free lighting. Our tool also features a pocket clip, and a bright nickel plated finish.



Part Number: 12-EM18

Telescoping pocket magnet

Packaging: Poly bagged & tagged

Includes:

1 - Telescoping magnet tool.

This handy device is a life saver in recovering dropped parts in hard to reach areas, with limited space. A necessity for any tool box. Tool features include a pocket clip, 18" extension reach, and a bright nickel plated finish.



Part Number(s):

- 12-T180 (Temp. range -40 to 160 degrees Fahrenheit)
- 12-T220 (Temp. range 0 to 220 degrees Fahrenheit)
- Thermometers - Pocket dial

Packaging: Poly bagged & tagged

Includes:

1 - Pocket thermometer of choice with casing

Used in a variety of applications: Heating, AC, Refrigeration and Laboratory use to mention a few. This tool features a unbreakable lens, 5" stem, protector sleeve with clip. The pocket clip also holds the thermometer in place.



Part Number: 12-T302

Thermometers - Digital pocket dial

Packaging: Shell packaged for display

Includes:

1 - Digital Pocket thermometer & casing

Used in a variety of applications: Heating, AC, Refrigeration, food and Laboratory use to mention a few.

This tool features a flat edge non-roll case, stainless steel 5" stem, large display, on/off switch, instant one second update. It has a temperature range of -40 to 302 degrees Fahrenheit and switchable to -40 to 150 degrees Centigrade. The protector sleeve has a pocket clip that also holds the thermometer in place and the battery is included.



Part Number: 12-T3N1

Telescoping mirror, magnet & light kit

Packaging: Shell packaged for display in case

Includes:

- 1 - Telescoping mirror,
- 1 - Telescoping magnet & light tool
- 1 - Sturdy case

This sturdy plastic case keeps your kit safe from damage in your tool box. Each kit contains a telescoping round mirror 2" in diameter that extends to 36" and a telescoping 5 lb. magnet with a built in LED light that extends to 26" to guide the way. This tools also features non-slip, textured PVC coated handles, batteries are included, ready to use off the shelf.



NEW

Section 8 - Tools, Glass, Washers & V-Belts



Part Number: 40400
 Tools - Terminal crimping
Packaging: Poly bagged & tagged
Includes:
 1 - Terminal crimping tool in poly bag.
 Our tool is lightweight, and economical.
 This multi-purpose tool is made for durability.
 Handles are plastic coated for comfort.



- Four Tools In One -
- Bolt cutter - Wire cutter - Crimper - Wire stripper

Part Number: 40402
 Tools - Coupling cutter
Packaging: Poly bagged & tagged
Includes:
 1 - heavy duty coupling cutter.
 Cuts all sizes up to 1 1/4" in diameter.
 Cuts polyethylene, PVC, ABS, and rubber
 hose materials. Will not distort pipe shape
 when cutting.

For replacement blades for 40402,
 Use **P/N: 40403** (a pack of two).



NEW

Part Number: 40403
 Tools - Replacement blades for 40402
Packaging: Poly bagged & tagged
Includes:
 1 - 2 pack of replacement blades for 40403 tool.
 The blades are sharp. Please exercise caution when
 replacing blades.

Part Number: 40406
 Tools - Lineman's pliers
Packaging: Poly bagged & tagged for display
Includes:
 1 - heavy duty lineman's crimping tool.
 This 9 1/2" long tool is a multi-tasker in the field.
 It cuts, and crimps our and terminal connector very
 sure and secure. Solid steel construction with foam type
 handles for a sure grip!

FEATURES

- * CROSS SECTIONED JAWS
- * INDUCTION HARDENED CUTTING EDGES.
- * HOT RIVETED JOINTS
- * TEXTURED NON-SLIP GRIP

NEW

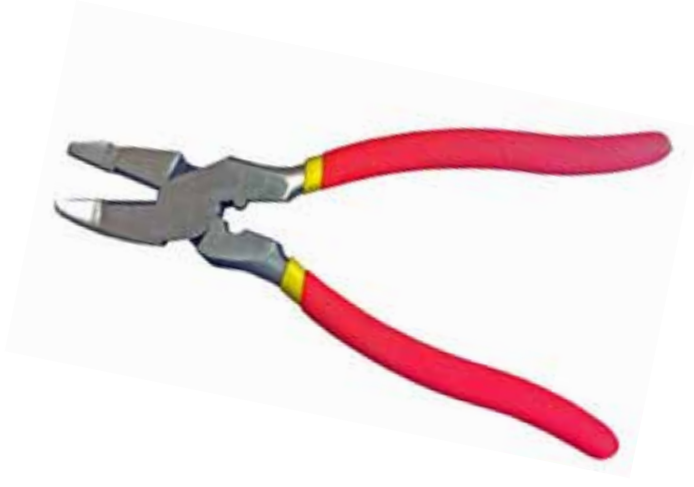



Part Number: 40407
 Tools - Automotive crimper - Manual

NEW

Packaging: Poly bagged & tagged

Includes:

1 - Automotive Terminal crimping tool in poly bag.
 An automotive favorite and wire harness builder for the HVAC Tech. An essential for the service-person in the field for "on the fly" wire harness modifications. Made of high carbon steel with black oxide finish and plastic hand grips for a sure grip.

- Four Tools In One -
- Bolt cutter - Wire cutter - Variety Crimper - Wire stripper



Part Number: 40408
 Tools - Automotive crimper - Ratcheting

NEW

Packaging: Poly bagged & tagged

Includes:

1 - Automotive Terminal crimping tool in poly bag.
 An automotive favorite and wire harness builder for the HVAC Tech and wire harness pro. Create "sure" connections in high use areas, An essential for the service-pro in the field for "on the fly" wire harness modifications. The positive ratcheting mechanism adjusts for perfect crimps. Supplied with a variety of crimping jaws that cover a wide variety of wire terminals. Never get caught without the "right" tool. A hardened steel frame design insures longevity and plastic hand grips for a sure grip.



Part Number:
 40417 (for 1 soot kutter)
 40417-12 (for 12 soot kutters)
 Tools - Soot kutter

Packaging: Poly bagged & tagged for display

Includes:

1 - Soot kutter or 1 - 12 pk. of soot kutters
 Our Soot Kutter is specially designed for easier clearing of soot build-up in most narrow passage boilers. Effectively breaks up hardened carbon deposits. Handle is plastic coated for comfort.

Soot Kutter!



32" Over-all Length

Section 8 - Tools, Glass, Washers & V-Belts



Part Number: 40420
 Tools - Porcelain & gauge glass cutter
Packaging: Poly bagged & tagged
Includes:

1 - Tool with cutting chain.
 The industry standard and design for cutting insulators and gauge glass in the field. Simple to use, as a pair of pliers. Plastic coated handles for comfort grip.

Squeeze & Pop!



Part Number: 40421
 Tools - Hex key set
Packaging: Plastic holder
Includes:

1 - Holder with 8 hex keys
 Sizes are:
 .050, 1/16, 5/64, 3/32, 1/8, 5/32, 3/16, & 7/32
 The two smallest sizes .050 and 1/16 are 1 3/4" long. All the others are 6" long. The plastic holder ensures you'll never mis-place a hex key ever again, an essential for any tool box.



Part Number: 40424
 Tools - Plier style glass cutter
Packaging: Poly-bagged & tagged
Includes:

1 - Gauge glass cutter
 The plier style gauge glass cutter offers good leverage on scoring the glass tubing by a conventional means that most mechanics are familiar with.



Part Number: 40425
 Tools - Squeeze rod style glass cutter
Packaging: Poly-bagged & tagged
Includes:

1 - Gauge glass cutter
 Works similar to the plier style gauge glass cutter. It offers good leverage on scoring the glass tubing by a means squeezing flexible rods together.



Part Number(s):
 40428 (Standard blowout gun)
 40429 (Gun with 150 psi safety valve)
 Tools - Blowout guns
Packaging: Poly bagged & tagged

Includes:
 1 - Blowout gun and instruction sheet.
 Our blowout gun uses a CO² cartridge (sold separately) and incorporates a 1/4" NPT female connection, that can be adapted to other fittings. It is intended for use in blowing out clogged lines that are vented beyond the restricted point to the atmosphere. It should not be used in a closed end line. Applications include fuel oil lines, machine lubrication systems, instrument transmission lines, and hydraulic pipelines.

The blowout gun with the built in check valve allows the user the ability to remove used CO² cartridges without pressure line loss. You can then add additional CO² cartridges as needed, up to 150 psi.

Replacement O-rings are available ask for P/N: 40427-10



P/N: 40428



P/N: 40429



Part Number: 40430
 Tools - Electrode tip benders
Packaging: Poly bagged & tagged
Includes:
 2 - Tip benders.
 Made of steel with a plated finish. Used for bending and adjusting electrode and igniter tips, this lightweight tool is pocket size and easy to use. One end accommodates 1/8" tips and the other 3/32" tip. A must to take on every service call.



Part Number(s):
 40431 (Control Blast - only)
 40431K (Control Blast with 3 - 12g cartridges)
 40432K (Control Blast with 3 - 16g cartridges)
 Tools - Control Blast blow-out gun
Packaging: Poly bagged & tagged
Includes:
 1 - Control Blast gun or kits from above list
 Crown puts you in control with our new trigger activated blow out gun and our new bigger and better 12 or 16 gram CO² cartridge. Together they supply the "control" and power "blast" you need to get rid of stubborn oil line clogs.



Control Blast

Part Number: 40434
 Tools - Eliminator Tape Measure
Packaging: Shell packaged
Includes:
 1 - Tape measure 7/8" W tape X 25 Ft. Long
 A patent hook allows for un-assisted measurements on long pipe lengths. It's "The Pipe Friendly" tape measure with easy to read fractional markings. A must have for the tool box for the plumber in you!

NEW!



Part Number: 40436
 Tools - Ratchet box wrench
Packaging: Poly bagged & tagged for display
Includes:
 1 - Ratchet combo box wrench
 Made of steel with a plated finish.
 Accommodates a 1/4" hex and a 5/16" hex.



Part Number: 40437
 Tools - Nozzle Wrench
Packaging: Poly bagged & tagged
Includes:
 1 - Nozzle Buddy Wrench
 Our "Nozzle Buddy," tool gets the job done! Install and remove nozzles with ease. Works on all nozzle brands and most adaptors..
 IMPROVED PIN STRENGTH.



NOZZLE BUDDY

Section 8 - Tools, Glass, Washers & V-Belts



Electrode Setting Gauges

Crown carries a full line of specialty setting gauges for Beckett, Carlin, and Wayne burners so that you get a perfect spray pattern every time you set an electrode. Why chance an unnecessary call back?. Set it right the first time with our original line of O.E.M. electrode setting gauges. But that's not all! Use Crown's universal electrode setting gauge if a specialty gauge is not available. It's quick and easy to use for setting all spray patterns!

Crown Part Number	For Model Number	O.E.M. Name
40439	NX & AF II, HLX / AF2	Beckett
40441	AF, AFG, SR, SF & AF II with F & FB retention heads	Beckett Z Gauge
40442	SR Series Burner	Wayne
40443	AF, AFG, SR, & SF	Beckett
40444	Blue Angel HS	Wayne
40445	All Models	Various
40447	99-102	Carlin
40448	Elite	Carlin



Part Number(s):

40492-06 (6 pack - 12 gram CO² cartridges)
 40494-06 (6 pack - 16 gram CO² cartridges)
 CO² cartridges 12 & 16 gram



Packaging: Poly bagged & tagged

Includes:

1 - Of the above CO² charger combinations above.
 Intended for use in blowing out clogged oil lines with our blow out gun 40431 Control Blast. this product can be used in a variety of applications ranging from making seltzer water to use in CO² bb-guns.

Part Number: 49925

Tools - Webster vacuum breaker

Packaging: Poly-bagged & tagged

Includes:

1 - Vacuum Breaker with instructions.
 This handy device incorporates a Viton "O" ring seat, a 3/8-18 (f)NPT port. It can also be used as a supply line check valve.



Part Number: 695

Tools - Lineman's strip n' crimp pliers

Packaging: Poly bagged & tagged

Includes:

1 - Lineman's wire stripper and crimper
 This tool gives you all the benefits of a standard lineman's pliers plus wire stripping and terminal crimping features.
 A must have for the tool box!

Strip N' Crimp!



Part Number(s):

40490 (10 - 8gram cartridges per box)
 40490-12 (12 - 10 pk. boxes per case)
 40490-36 (36 - 10 pk. boxes per case)
 CO² cartridges - Std. 6 gram



Packaging: Boxed

Includes:

1 - Of the above CO² charger combinations above.
 Intended for use in blowing out clogged oil lines with our blow out gun 40428 or 40429, this product can be used in a variety of applications ranging from making seltzer water to use in CO² bb-guns.



Part Number: OSVA TOOL
 Tools - OSVA Tool

Packaging: Poly-bagged & tagged

Includes:

1 - OSVA Tool with instructions.
 This handy tool makes fuel pump priming operations look easy.
 Inexpensive yet effective.
 Another reason to stock and install Webster OSV valves.
 Our P/N's: OSVA50 & OSVA38!



Part Number: PTK-10M
 Pump test manifold tester kit

Packaging: Sturdy plastic case

Includes:

1 - Test kit
 Used to test pump pressure and cutoff of fuel oil pumps quickly and accurately.
 No need to remove pump from oil burner.
 Can be used on all pumps with operating pressures up to 300 psi.
 Use with vacuum gauge to analyze problems in oil lines caused by impurities, leaks and high restrictions.



Part Number: PTK-2M
 Pressure & cut off tester kit

Packaging: Sturdy plastic case

Includes:

1 - Test kit
 Tests pump pressure and cut-off of fuel oil pumps quickly and accurately without removing the pump from the oil burner.
 Can be used on all pumps with operating pressures up to 300 psi.

This Kit Features:

- Quick hook-up fittings make testing easy, clean and simple.
- Easy-to-follow step-by-step instructions
- Checks operating pressure & cut-off under actual operating conditions.
- Color coded hoses.
- Liquid filled gauge
- All brass body.
- High impact case.

This Kit Features:

- Quick hook-up fittings for easy testing.
- Accurately checks pressure, cutoff and vacuum under actual operating conditions.
- Liquid filled gauges for accurate readings.
- High pressure hoses for setting up today's higher pressure pumps.
- High impact case with handle.
- Complete with easy-to-follow instructions.
- Brass and high quality aluminum construction for long life.
- Color coded hoses for pressure hook-up.
- Clear tubing adapts to any suction line.
- Adapter fittings included for all pumps including Riello.

Part Number: PTK-T20
 Riello pump & vacuum tester kit

Packaging: Sturdy plastic case

Includes:

1 - Test kit

Designed specifically for testing Riello pumps and vacuum.



This Kit Features:

- Quick connect European thread fittings.
- Liquid filled gauges to dampen pulsation.
- No hydraulic shock.
- 24" color coded flexible lines.
- High impact plastic case.



Section 8 - Tools, Glass, Washers & V-Belts



Part Number: PTK-9183

Pump test kit

Packaging: Sturdy plastic case

Includes:

- 1 - Manifold
- 1 - Vacuum gauge
- 1 - Pressure gauge
- 1 - 1/8" NPT X 1/2" hex adapter
- 1 - 1/4" NPT X 1/2" hex adapter
- 1 - 6" Clear flexible hose w/fittings
- 1 - Instruction sheet



Our pump test kit performs a variety of tests. Benefits include the ability to trouble shoot pump failure, valve failure, and vacuum leaks all in one convenient kit.

Test Applications

- Operating Pressure Test
- Cut-Off Test
- Vacuum Test - Lift Application
- Vacuum Test - Fuel Unit

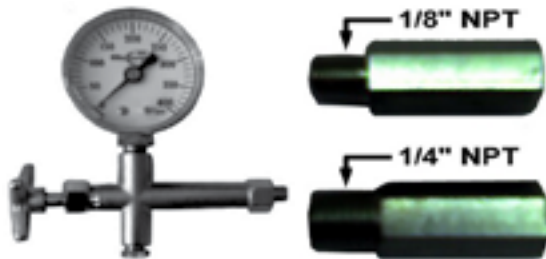

Part Number: SW1

Silicone Tape

Packaging: Poly-bagged & tagged

Includes:

1 - roll 1" W x 12 Yard x .020 thick Silicone tape. This product has thousands of uses. It has 300% elongation stretch capacity. It fuses to itself to form an inseparable bond after 24 hours at room temperature and is water resistant. A great low cost seal in electrical insulation, splicing, and wire wrapping applications. 500° F continuous temperature rating.



Part Number: WP-1

Tools - "W" glass cutter

Packaging: Poly-bagged & tagged

Includes:

- 1 - Gauge glass cutter

This "W" shaped gauge glass cutter offers good leverage in that the mechanic can really lean into the score with their body weight making for deep cuts and easy tap & snap secondary process.



AQUASTAT IMMERSION WELLS

Replacement Wells for Honeywell and White Rodgers. Sturdy brass and copper construction for long service life.

Part Number	Description	Honeywell Part Number
PMW-2S	1/2" Standard / 4 7/8" OAL	121371 A
PMW-2SE	1/2" Extended / 6 3/8" OAL	121371 L
PMW-3S	3/4" Standard / 4 7/8" OAL	121371 B
PMW-3SE	3/4" Extended / 6 3/8" OAL	121371 M



PMW-2S

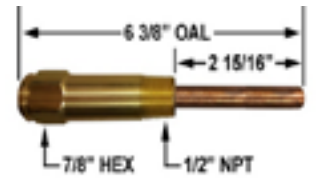

PMW-2SE

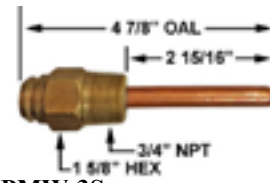

PMW-3S



PMW-3SE



Gauge Glass Washers - Marvel®

What makes these washers different from others is its patinent molded lip design that ensures a sure seal. Made of standard EPDM rubber that can withstand up to 150 psi and 300° F constant pressure and temperature enviornments with outstanding longevity. The Marvel washers are sold in packages of 12 or individually.



Marvel® Gauge Glass Washers			
Part Number	Size of Glass	OUTSIDE DIMENSIONS	
		DIA.	DEPTH
GGW01-12	1/2"	13/16"	9/32"
GGW02-12	1/2"	7/8"	1/2"
GGW03-12	5/8"	7/8"	9/32"
GGW04-12	5/8"	1"	9/32"
GGW05-12	5/8"	1-1/8"	3/8"
GGW06-12	3/4"	1-1/16"	9/32"
GGW07-12	3/4"	1-1/4"	13/32"
GGW08-12	3/4"	1-5/16"	13/32"
GGW09-12	5/8"	15/16"	9/16"
GGW10-12	3/4"	1-7/16"	13/32"
GGW11-12	3/4"	1-3/16"	13/32"
GGW12-12	9/16"	27/32"	19/32"
GGW13-12	5/8"	15/16"	9/32"
GGW14-12	3/4"	1-1/8"	3/8"
GGW15-12	3/4"	1-1/16"	1/2"
GGW16-12	3/4"	1-5/16"	5/8"
GGW17-12	3/4"	1-1/8"	5/8"
GGW18-12	9/16"	1-3/32"	1/2"
GGW19-12	9/16"	13/16"	9/32"
GGW20-12	11/16"	1"	9/32"
GGW21-12	1/2"	7/8"	3/8"
GGW22-12	3/4"	1-1/4"	1/4"
GGW23-12	3/4"	1-1/4"	3/4"
GGW24-12	3/4"	1-3/32"	13/32"
GGW25-12	5/8"	1"	15/32"
GGW26-12	1"	1-5/8"	1/2"
GGW27-12	7/8"	1-3/8"	13/32"
GGW28-12	1/2"	1"	3/8"
GGW29-12	1/2"	1"	5/16"

Marvel® Gauge Glass Washers			
Part Number	Size of Glass	OUTSIDE DIMENSIONS	
		DIA.	DEPTH
GGW30-12	3/8"	13/16"	1/4"
GGW31-12	3/4"	1"	3/8"
GGW32-12	3/4"	1-3/8"	1/4"
GGW33-12	3/4"	1-1/8"	1/2"
GGW34-12	1/2"	1-7/16"	3/8"
GGW35-12	5/8"	1-15/16"	13/32"
GGW36-12	1-1/4"	1-7/8"	1-15/16"
GGW37-12	5/8"	1-1/4"	1/2"
GGW38-12	1"	1-1/2"	1"
GGW39-12	3/4"	1-1/8"	7/16"
GGW40-12	31/32"	1-3/4"	3/8"
GGW41-12	3/4"	1-3/8"	3/8"
GGW42-12	11/16"	1-3/16"	7/16"
GGW43-12	3/4"	1"	3/4"
GGW44-12	11/16"	1-3/8"	3/8"
GGW45-12	3/4"	1-15/16"	3/8"
GGW46-12	3/4"	1-5/8"	1/2"
GGW47-12	3/4"	1-1/16"	3/4"
GGW48-12	31/32"	1-3/4"	7/16"
GGW49-12	1-7/8"	2-1/4"	3/4"
GGW50-12	21/32"	1-1/4"	1/4"
GGW51-12	11/16"	1-1/8"	3/8"
GGW52-12	5/8"	7/8"	3/8"
GGW53-12	3/4"	1-1/4"	1/2"
GGW54-12	3/4"	1-1/8"	7/8"
GGW55-12	7/8"	1-31/64"	7/8"
GGW56-12	11/16"	1-7/16"	13/32"
GGW57-12	3/4"	15/16"	3/8"

Section 8 - Tools, Glass, Washers & V-Belts



Gauge Glass Washers - Standard

GLASS DIAMETER	PART NUMBER	WASHER SPECIFICATIONS		WALL
		I.D.	O.D.	
5/8"	GGW58	9/16"	11/16"	1/4"
3/4"	GGWS34	3/4"	15/16"	1/4"
1/2"	GGWS12	7/16"	11/16"	5/16"



****PLEASE SPECIFY -12 OR -100 AT END OF PART NUMBER FOR 12 PER PACKAGE OR 100 PER PACKAGE. FOR 5/8", 3/4", & 1/2" GAUGE GLASS WASHER.**

NOTE: GGW58 HAS A TEMPERATURE RATING OF 250° F.

Friction Rings - Brass

GLASS DIAMETER	PART NUMBER	WASHER SPECIFICATIONS		
		I.D.	O.D.	THICK
5/8"	58BW-12	5/8"	27/32"	1/32"
3/4"	34BW-12	3/4"	15/16"	1/32"



****58BW-12 IS USED WITH GGW58 GAUGE GLASS WASHERS**

****34BW-12 IS USED WITH GGW34 GAUGE GLASS WASHERS**

Part Number(s):

- 70321 (Conbraco Quality Valve Set)
 - 70323 (same as 70321 but has safety check valve)
 - 70324 (Contains same as below, but 3/4 NPT & GG 16" L)
- Gauge Glass Valve Kit - Conbraco©

Packaging: Boxed & GG in corrugated tube

Includes:

MADE IN THE USA

- 2 - Protection rods
 - 1 - 5/8" OD X 12" Long standard gauge glass
 - 1 - 5/8" ID X 1/2" NPT top valve
 - 1 - 5/8" ID X 1/2" NPT bottom valve with clear out port
 - 1 - Instruction sheet
- Use for all types of liquid level verification; We stock the 1/2" NPT male pipe version, but 3/8" NPT is available upon request.

Features:

- Aluminum composition hand wheels
- EPDM gauge glass gaskets standard
- Automatic ball checks help prevent the loss of fluids should the glass be broken.
- Equipped with two copper guard rods
- Standard 1/4" needle drain valve in lower arm
- Rated: 125 psig @ 350°F, 300 psig @ 100°F (See note!)
- CRN Registered OF6616.5C

Note: Service ratings are subject to pressure/temperature ratings of gauge glass and glass gaskets.



'Apollo' Valves
 Manufactured by Conbraco Industries Inc.

Part Number:

- 70322 (5/8 ID kit)
 - 70325 (3/4 ID kit)
- Gauge Glass packing nut kit

NOTE:
 Packing nuts can be purchased individually.
 Use P/N: 58PN



Packaging: Boxed

Includes:

- 2 - 5/8" ID gauge glass packing nuts (58PN)
- 2 - 5/8" ID gauge glass washers (GGW58-12 or GGW58-100)
- 2 - 5/8" ID gauge glass friction rings (58BW-12)

This kit includes everything you need to repair leaking valves in the field. If individual items are needed specify the P/N's in parenthesis.

Part Number(s): 70320

Gauge Glass Valve Kit - Economy

Packaging: Boxed

Includes:

- 2 - Protection rods 10" L
- 2 - 5/8" ID X 1/2" NPT valve with clear out port
- 1 - Instruction sheet

A cheap economy valve. Features identical valves. Either one can be used as a bottom valve for installation ease.





Standard Tubular Gauge Glass 5/8" and 3/4" Diameter

Gauge Glass - Standard				
Our 5/8" DIA. soda lime glass is an industry standard. Used in low steam boiler applications. Easy to cut!			MAXIMUM RECOMMENDED WORKING PRESSURE, psi	
OUTER DIAMETER	PART NUMBER	OVER-ALL LENGTH	TEMP UP TO 150° F	STEAM BOILER UP TO 425° F
5/8"	58GG08	8"	205	100 psi
5/8"	58GG10	10"	205	100 psi
5/8"	58GG12	12"	205	100 psi
5/8"	58GG14	14"	190	100 psi
5/8"	58GG16	16"	190	100 psi
5/8"	58GG18	18"	190	100 psi
5/8"	58GG20	20"	185	100 psi
5/8"	58GG24	24"	180	100 psi
5/8"	58GG30	30"	175	**
5/8"	58GG36	36"	165	**
5/8"	58GG48	48"	140	**
5/8"	58GG60	60"	120	**
3/4"	34GG08	08"	205	100 psi
3/4"	34GG10	10"	205	100 psi
3/4"	34GG12	12"	205	100 psi
3/4"	34GG14	14"	200	100 psi
3/4"	34GG16	16"	195	100 psi
3/4"	34GG18	18"	190	100 psi
3/4"	34GG24	24"	180	**
3/4"	34GG36	36"	165	**
3/4"	34GG48	48"	140	**

** MAXIMUM RECOMMENDED LENGTH IN THIS SERVICE IS 24"

5/8" DIA. STANDARD SODA LIME GAUGE GLASS

8" to 12" sold in 12 packs.
 14" to 36" sold in 6 packs.
 48" & 60" sold individually.

Our Type I Clear Borosilicate glass has been an industry standard for eons!

Our glass tubing is widely used in low pressure steam boiler applications.

Easily cut to size in the field.
 - High Chemical Durability
 - High Hydraulic Resistance

Use Crown's premium Squeeze & Pop cutter #40420.

Sizes are standard, and we will cut to length upon request special lengths. Please call for price & availability.

3/4" DIA. STANDARD GAUGE GLASS

Sold individually.

Section 8 - Tools, Glass, Washers & V-Belts



Gauge Glass - High Pressure

Our popular Schott brand Borosilicate gauge glass is very durable.

MAXIMUM RECOMMENDED WORKING PRESSURE, psi

OUTER DIAMETER	PART NUMBER	OVER-ALL LENGTH	TEMP UP TO	STEAM BOILER
			150° F	UP TO 425° F
1/2"	12HP08	8"	460	340 psi
1/2"	12HP10	10"	445	335 psi
1/2"	12HP12	12"	435	325 psi
1/2"	12HP14	14"	415	315 psi
1/2"	12HP16	16"	400	300 psi
1/2"	12HP18	18"	385	295 psi
1/2"	12HP20	20"	375	285 psi
1/2"	12HP24	24"	340	270 psi
1/2"	12HP30	30"	295	**
1/2"	12HP36	36"	260	**
1/2"	12HP48	48"	205	**
1/2"	12HP60	60"	155	**
3/4"	34HP08	8"	425	315 psi
3/4"	34HP10	10"	410	310 psi
3/4"	34HP12	12"	400	300 psi
3/4"	34HP14	14"	385	290 psi
3/4"	34HP16	16"	370	280 psi
3/4"	34HP18	18"	355	275 psi
3/4"	34HP20	20"	345	265 psi
3/4"	34HP24	24"	315	250 psi
3/4"	34HP30	30"	275	**
3/4"	34HP36	36"	240	**
3/4"	34HP48	48"	190	**
3/4"	34HP60	60"	145	**
5/8"	58HP08	8"	435	320 psi
5/8"	58HP10	10"	420	315 psi
5/8"	58HP12	12"	410	305 psi
5/8"	58HP14	14"	390	295 psi
5/8"	58HP16	16"	375	285 psi
5/8"	58HP18	18"	360	280 psi
5/8"	58HP24	24"	320	255 psi
5/8"	58HP36	36"	245	**
5/8"	58HP48	48"	165	**
5/8"	58HP60	60"	150	**



5/8" DIA. HIGH PRESSURE DURAN® BOROSILICATE GLASS 3.3

Sold individually.

These are made from Schott's heat resistant Borosilicate® brand tubing. It is highly resistant to water, neutral, acid solutions, concentrated acids, acid mixtures, as well as chlorine, bromine, iodine and organic substances.

They are the most versatile and popular type used in our industry.

Application: Sight & flow indicators.

Benefits: Visual indication of liquid flow, contamination or discoloration of liquid, metering a constant rate of flow through a fixed port .

End Finish: Saw cut and fire-polished

NOTE: Harsh environments should be monitored daily. As temperatures rise so will corrosion levels. If clouding is observed replace tubing.

** MAXIMUM RECOMMENDED LENGTH IN THIS SERVICE IS 24"



Gauge Glass - Red Line

It's very easy to spot liquid levels from a distance when you use our DURAN® brand redline tubular gauge glass.			MAXIMUM RECOMMENDED WORKING PRESSURE, psi	
OUTER DIAMETER	PART NUMBER	OVER-ALL LENGTH	TEMP UP TO 150° F	STEAM BOILER UP TO 425° F
1/2"	12RL10	10"	370	295 psi
1/2"	12RL12	12"	360	295 psi
1/2"	12RL14	14"	345	290 psi
1/2"	12RL16	16"	335	285 psi
1/2"	12RL24	24"	280	270 psi
1/2"	12RL36	36"	215	**
1/2"	12RL48	48"	175	**
3/4"	34RL12	12"	330	275 psi
3/4"	34RL14	14"	320	270 psi
3/4"	34RL16	16"	310	265 psi
3/4"	34RL18	18"	300	260 psi
3/4"	34RL20	20"	285	260 psi
3/4"	34RL24	24"	260	250 psi
3/4"	34RL36	36"	200	**
3/4"	34RL48	48"	160	**
5/8"	58RL08	8"	370	285 psi
5/8"	58RL08 1/2	8 1/2"	370	285 psi
5/8"	58RL09 1/2	9 1/2"	370	285 psi
5/8"	58RL09 1/4	9 1/4"	370	285 psi
5/8"	58RL09 3/4	9 3/4"	370	285 psi
5/8"	58RL09 5/8	9 5/8"	370	285 psi
5/8"	58RL10	10"	345	280 psi
5/8"	58RL10 1/2	10 1/2"	345	280 psi
5/8"	58RL10 1/4	10 1/4"	345	280 psi
5/8"	58RL10 3/4	10 3/4"	345	280 psi
5/8"	58RL11 1/2	11 1/2"	345	280 psi
5/8"	58RL11 1/4	11 1/4"	345	280 psi
5/8"	58RL11 3/4	11 3/4"	345	280 psi
5/8"	58RL12	12"	335	280 psi
5/8"	58RL14	14"	325	275 psi
5/8"	58RL16	16"	315	270 psi
5/8"	58RL18	18"	305	265 psi
5/8"	58RL24	24"	265	255 psi
5/8"	58RL28	28"	235	**
5/8"	58RL36	36"	205	**
5/8"	58RL48	48"	165	**
5/8"	58RL60	60"	**	**
5/8"	58RL72	72"	**	**

** MAXIMUM RECOMMENDED LENGTH IN THIS SERVICE IS 24"



DURAN® BRAND REDLINE GAUGE GLASS

It's very easy to spot liquid levels from a distance when you use our DURAN® brand redline tubular gauge glass. The red stripe on a white background gives a special optical effect which makes the liquid level stand out clearly. This feature allows for easy viewing of liquid levels from across the room.

1/2" Diameter

Sold individually.

5/8" Diameter

Sold per dozen (12 per case)
24" to 72" sold individually.

Stocked Odd Sizes

We stock the following odd sizes in 5/8" Dia. lengths: 8 1/2", 9 1/4", 9 1/2", 9 3/4", 10 1/4", 10 1/2", 10 3/4", 11 1/4", 11 1/2", & 11 3/4"

Other lengths are available.

Minimum quantities required on all special orders.

3/4" Diameter

Sold individually.

Section 8 - Tools, Glass, Washers & V-Belts



Heavy Wall Red Line Gauge Glass

It's very easy to spot liquid levels from a distance when you use our DURAN® brand redline tubular gauge glass.			MAXIMUM RECOMMENDED WORKING PRESSURE, psi	
OUTER DIAMETER	PART NUMBER	OVER-ALL LENGTH	TEMP UP TO 150° F	STEAM BOILER UP TO 425° F
3/4"	34RLHW12	12"	600	340 psi
3/4"	34RLHW14	14"	600	335 psi
3/4"	34RLHW16	16"	600	325 psi
3/4"	34RLHW18	18"	600	320 psi
3/4"	34RLHW20	20"	600	315 psi
3/4"	34RLHW24	24"	580	300 psi
3/4"	34RLHW36	36"	500	**
3/4"	34RLHW48	48"	340	**
5/8"	58RLHW10	10"	600	345 psi
5/8"	58RLHW12	12"	600	340 psi
5/8"	58RLHW14	14"	600	335 psi
5/8"	58RLHW16	16"	600	325 psi
5/8"	58RLHW18	18"	600	320 psi
5/8"	58RLHW24	24"	580	300 psi
5/8"	58RLHW36	36"	500	**
5/8"	58RLHW48	48"	340	**
** MAXIMUM RECOMMENDED LENGTH IN THIS SERVICE IS 24"				



DURAN® BRAND
HEAVY WALL
REDLINE GAUGE GLASS

It's very easy to spot liquid levels from a distance when you use our DURAN® brand redline tubular gauge glass. The red stripe on a white background gives a special optical effect which makes the liquid level stand out clearly. This feature allows for easy viewing of liquid levels from across the room. Use our heavy wall for those high temp and pressure application.

3/4 & 5/8" Diameter

Sold individually.
Additional packaging charges may apply on longer lengths.

Gauge Glass Protector Rods

Our gauge glass protector rods are made from .1875 diameter Stainless Steel and crimped on one end to catch the eyelets of the valves they are used on.
Custom sizes are no problem and ships in two days!

Gauge Glass Protector Rods

Part Number	Description	For Use On
GGR14	14" GG PROTECTOR RODS - 2/PK	12" LONG GAUGE GLASS
GGR18	18" GG PROTECTOR RODS - 2/PK	16" LONG GAUGE GLASS
GGR26	26" GG PROTECTOR RODS - 2/PK	24" LONG GAUGE GLASS
GGR36	36" GG PROTECTOR RODS - 2/PK	34" LONG GAUGE GLASS
GGR38	38" GG PROTECTOR RODS - 2/PK	36" LONG GAUGE GLASS
GGR40	40" GG PROTECTOR RODS - 2/PK	40" LONG GAUGE GLASS
GGR50	50" GG PROTECTOR RODS - 2/PK	48" LONG GAUGE GLASS
GGR62	62" GG PROTECTOR RODS - 2/PK	60" LONG GAUGE GLASS
GGR74	74" GG PROTECTOR RODS - 2/PK	72" LONG GAUGE GLASS





V- Belts - Fractional



**Don't gamble on another brand...
 We have the winning hand!**



Our Industrial V-Belts are designed for a wide variety of applications including heating and AC. All of our belts meet or exceed RMA standards and under-go ISO-9001 test standards. Our belts are constructed from tough, long-lasting synthetic rubber, reinforced with low elongation polyester cords. Specially designed synthetic rubber compounds give heat and oil resistance, which ensures that the belt will perform day after day in a wide range of ambient temperatures.

We typically stock a wide range of dual A / 4L series belts. All other series are considered non-stock and usually ship between 3 - 7 working days upon receipt of order.

Our Replacement Warranty

Our belts are warranted to be free from defects in materials and workmanship. This warranty is limited to replacing any belt, which is proven to be defective within 180 days from date of purchase under the following provisions:

- The belt was used in its designed application.
- The product is delivered to Crown with transportation charges prepaid (Call for RGA #)
- Analysis verifies that the product was properly handled, mounted, lubricated & not subject to abuse.

How To Order

- 1) Select desired belt: Fractional or Hi-Power.
- 2) Select top width and thickness desired.
Note: All of these belts are pitched at a 40 degree angle.
- 3) Select desired INSIDE length for A & B series or if ordering 3L, 4L or 5L, then select desired OUTSIDE length.
- 4) To order an A or B series belt that has an INSIDE length of 35", the part number would be A35 or B35.
- 5) To order a 3L, 4L, or 5L belt that has an OUTSIDE length of 35", the part number would be 3L350, 4L350 or 5L350.



Fractional Horsepower V-Belt Dimensions



Classical V-Belt Dimensions

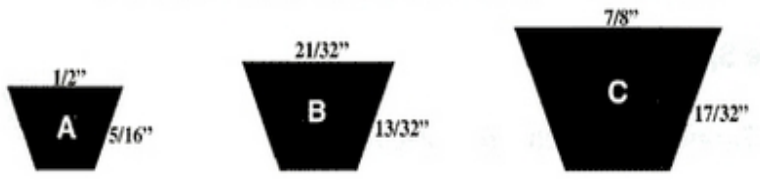

Section 8 - Tools, Glass, Washers & V-Belts



Serviceman's Trouble-shooting Chart

Reproduced by special permission of ICM magazine

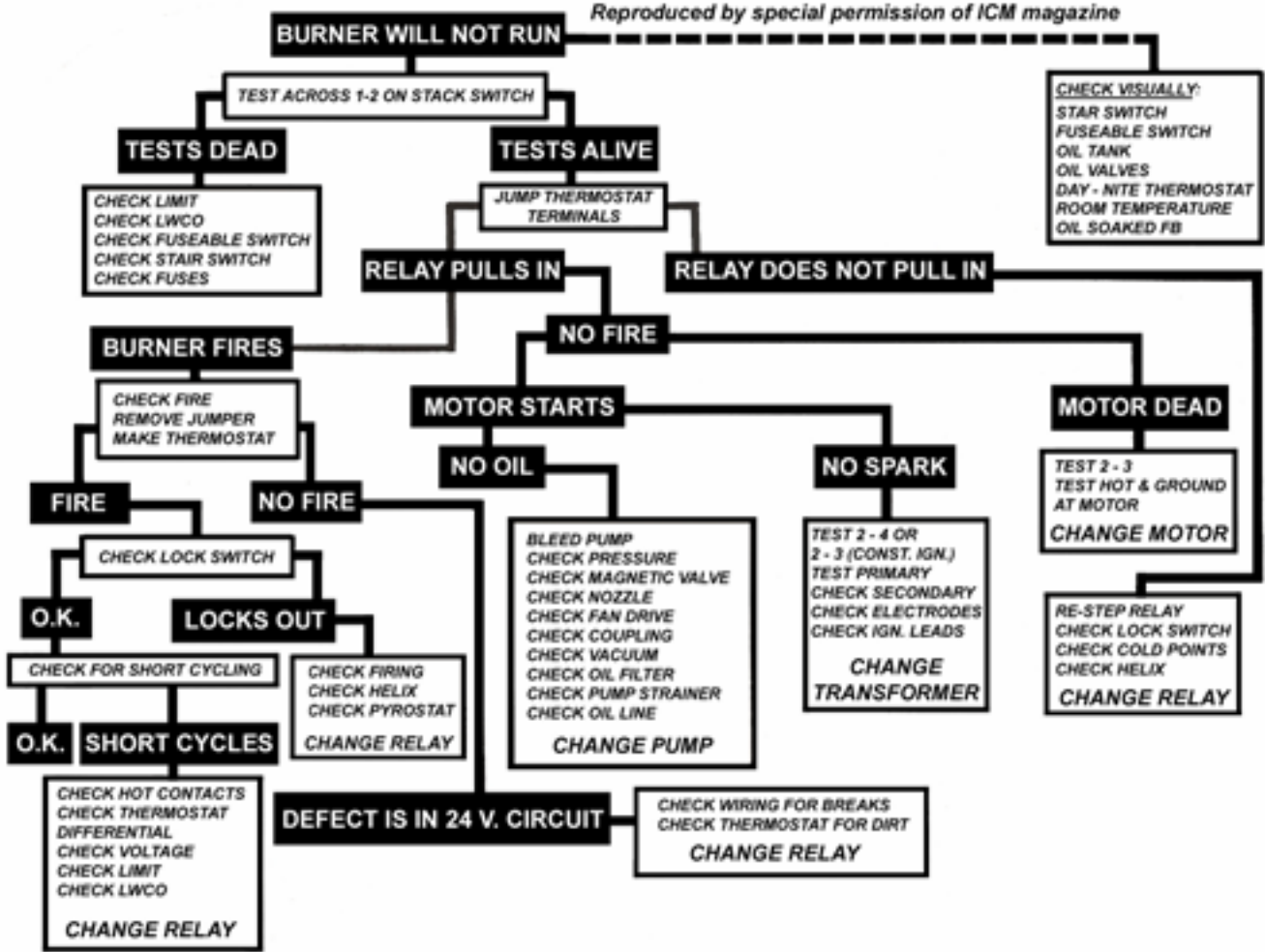

RECOMMENDED ELECTRODE SETTINGS FOR MOST HIGH PRESSURE GUN-TYPE OIL BURNERS
 (Unless otherwise specified by burner manufacturer)

Recommended spacing over surface of an insulator between any part of the electrode and nearest grounded metal part, as indicated below.

Secondary Voltage of Ignition Transformer	Minimum Surface Distance Over Insulator
Not more than 6,000	1"
Not more than 10,000	1½"
Not more than 15,000	2"

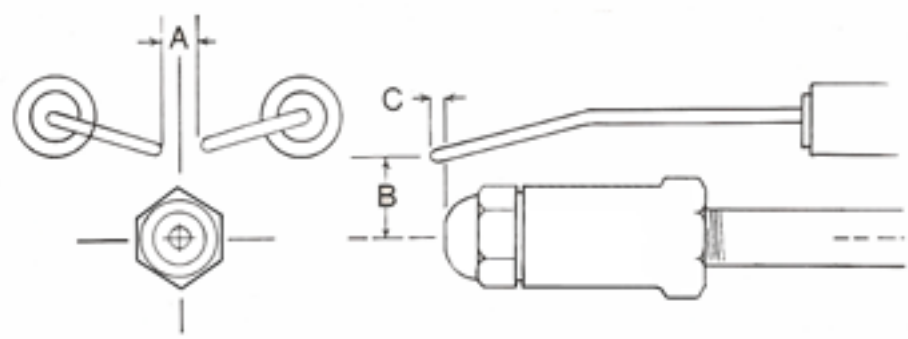

Nozzle GPH	A	B	C
45° (.75 to 4.00)	1/8" to 3/16"	1/2"	1/4"
60° (.75 to 4.00)	1/8" to 3/16"	5/8"	1/4"
70° (.75 to 4.00)	1/8" to 3/16"	5/8"	1/8"
80° (.75 to 4.00)	1/8" to 3/16"	5/8"	1/8"
90° (.75 to 4.00)	1/8" to 3/16"	5/8"	0

Above 4.00 gph it may be advisable to increase dimension "C" by 1/8" to insure smooth starting



Wayne's line of high performance stainless steel and cast iron air cones makes for higher efficiency, lower emissions, lower nozzle temperatures and improved flame control to prevent smoke and soot build-up, which is an important feature, since soot can block efficient heat transfer and reduce efficiency.

Air Cones for Wayne Burners

Part Number	Burner Model Number	Firing Rate G.P.H.	Material Type
12329	M & E	2.25 - 3.00	Cast Iron
12442	OE & M	.75 - 1.50	Cast Iron
12988	MH & EH Flamelock	.50 - 6.00	Stainless Steel
12988-002	Flamelock Nozzle w/adaptor	.50 - 6.00	Stainless Steel & Brass
12989	EH & MH	1.75 - 2.00	Cast Iron
12990	MH & EH	4.00 - 4.50	Cast Iron
13002	MH & EHA	1.00 - 1.50	Cast Iron
13003	MH, EH, & EHA	5.00 - 6.00	Cast Iron
13127	FH & FHA	7.00 - 11.00	Cast Iron
13128	FH	11.00 - 13.00	Cast Iron
13470	MOC80 & MOC100	.60 - .75	Cast Iron
13702	EH & EHA	3.00 - 5.00	Cast Iron
14157	#1ASR for MSR & EHASR	.75 - 1.00	Stainless Steel
14158	#2ASR for MSR & EHASR	1.00 - 1.50	Stainless Steel
14159	#3ASR for MSR & EHASR	1.60 - 2.00	Stainless Steel
14160	#4ASR for MSR & EHASR	2.00 - 2.25	Stainless Steel
14203	FH & FHA	4.00 - 7.00	Cast Iron
14302	#5ASR for MSR	.50 - 1.25	Stainless Steel
14365	#6ASR for MSR & EHASR	.75 - 2.00	Stainless Steel
14396	#8ASR for MSR & EHASR	1.75 - 3.00	Stainless Steel
100060	#SC for MSHR & MSR	.50 - .75	Stainless Steel
100328	#SD for HSRH-1	.75	Stainless Steel
100333	#SE for HSRH-1	.60	Stainless Steel
100389	HS	1.00 - 2.25	Cast Iron
100420	HS	.50 - 2.50	Cast Iron
100333-002	#SE2 for EG1 & MEG1	.60	Stainless Steel
100393-SER	HS for Flamelock 10 vane	3.00	Stainless Steel
100485-001	HS for Flamelock	.50 - .85	Stainless Steel
100531-001	HS	2.50 - 3.00	Cast Iron
14157-001	#1SR for HSR & EG1	.75 - 1.00	Stainless Steel
14160-004	#4SR for HSR & EG1	2.50 - 3.00	Stainless Steel
62393-001	HSG200	60-200 MBTU	Cast Iron

SEE PHOTOS ON NEXT PAGE

Section 9 - Other Burner Parts













 Back View P/N: 12329	 P/N: 12442	 P/N: 12988	 P/N: 12989	 P/N: 12990	 P/N: 13002
 P/N: 13003	 P/N: 13127	 P/N: 13128	 Back View P/N: 13470	 P/N: 13702	 P/N: 14157
 P/N: 14158	 P/N: 14159	 P/N: 14160	 Back view P/N: 14203	 P/N: 14365	 P/N: 14396
 P/N: 100060	 P/N: 100328	 P/N: 100333	 Side View P/N: 100389	 P/N: 100420	 P/N: 100333-002
 P/N: 100393-SER	 P/N: 100485-SER	 Back View P/N: 100531-001	 P/N: 14157-001	 P/N: 14160-004	 Side View P/N: 62393-001
 P/N: 12988-002					



Air Cones for Beckett Burners

Part Number	Burner Model Number	Firing Rate G.P.H.	Material Type
F0	AF & SR	.40 - .75	Stainless Steel
F0H	AF & SR with Heat Shield	.40 - .75	Stainless Steel
F12	AF, SR, & SF	1.10 - 2.25	Stainless Steel
F16	Special Application	Various	Stainless Steel
F22	AF, SR, & SF	1.25 - 3.25	Stainless Steel
F220	SF	1.75 - 3.25	Stainless Steel
F3	AF & SR	.75 - 1.25	Stainless Steel
F31	AF	2.50 - 3.00	Stainless Steel
F310	SF	2.50 - 5.50	Stainless Steel
F310	SF	2.50 - 5.50	Stainless Steel
F3H	AF & SR with Heat Shield	.75 - 1.25	Stainless Steel
F4	AF & AFG	1.75 - 1.35	Stainless Steel
F6	AF & SR	.85 - 1.65	Stainless Steel
FB0	AF II 85 & 150	.40 - 1.00	Stainless Steel
FB3	AF II 85 & 150	.55 - 1.20	Stainless Steel
FB4	AF II 150	1.10 - 1.25	Stainless Steel
FB5	AF II 150	1.15 - 1.35	Stainless Steel

 F0 0.40-0.75 gph P/N: F0	 P/N: F0H	 F12 1.10-2.00 gph P/N: F12	NO PHOTO P/N: F16	 F22 1.65-2.50 gph P/N: F22	NO PHOTO P/N: F220
 F3 0.75-1.25 gph P/N: F3	 F31 2.50-3.00 gph P/N: F31	NO PHOTO P/N: F310	NO PHOTO P/N: F3H	NO PHOTO P/N: F4	 F6 0.85-1.65 gph P/N: F6
 P/N: FB0	 P/N: FB3	 P/N: FB4	 P/N: FB5	NO PHOTO	NO PHOTO

Section 9 - Other Burner Parts

U.S. Postage
PAID
Farmingdale, NJ
Permit No. 72



PO BOX 846 - FARMINGDALE, NJ 07727

TEL: 800-631-2153 FAX: 888-645-7278

www.crownengineering.com